

Read This First

Operating Instructions

1 Checking the package contents
Sony CLIE™ handheld components

2 Charging your Sony
CLIE™ handheld

3 Performing the initial
settings

4 Basic operations of your
Sony CLIE™ handheld

5 Taking images/movies

6 Using your CLIE™ handheld
with your computer

Enjoying your CLIE™
handheld

Using applications

Personal Entertainment Organizer
PEG-NZ90

CLIE™

© 2003 Sony Corporation

 **Bluetooth™**

 **SmartLITHIUM**

MEMORY STICK

About this manual

This manual provides an overview of your CLIÉ™ handheld's features including information about setting up your CLIÉ™ handheld and what you can do with your CLIÉ™ handheld.

Checking the package contents

Page 10

Make sure that all the accessories are supplied in the package.

Sony CLIÉ™ handheld components

Page 12

Learn about the parts of your CLIÉ handheld and other accessories.

Charging your Sony CLIÉ™ handheld

Page 19

Be sure to charge your CLIÉ handheld before you start using it for the first time.

Performing the initial settings

Page 23

Configure the initial settings before operating your CLIÉ handheld.

Basic operations of your Sony CLIÉ™ handheld

Page 29

Learn about the basic operations of your CLIÉ handheld.

Taking images/movies

Page 50

Learn about the basic operations of your CLIÉ handheld.

Using your CLIÉ™ handheld with your computer

Page 65

Use your CLIÉ handheld with your computer.

Enjoying your CLIÉ™ handheld

Page 73

Learn about your CLIÉ handheld's features.

Using applications

Page 86

Learn about the applications supplied with your CLIÉ handheld.

WARNING

To prevent fire or shock hazard, do not expose the unit to rain or moisture. To avoid electrical shock, do not open the cabinet. Refer servicing to qualified personnel only.

For customers in the U.S.A and Canada

Owner's Record

The model number and serial number are located on the back of the product. Record the model number and the serial number in the space provided below. Refer to them whenever you call upon your Sony dealer regarding this product.

Model No. _____
Serial No. _____

The socket-outlet shall be installed near the equipment and shall be easily accessible.

CAUTION

You are cautioned that any changes or modifications not expressly approved in this manual could void your warranty on this equipment.

This Class B digital apparatus complies with Canadian ICES-003.

Cet appareil numérique de la classe B est conforme à la norme NMB-003 du Canada.

Danger of explosion if battery is incorrectly replaced.

Replace only with the same or equivalent type recommended by the manufacturer. Dispose of used batteries according to the manufacturer's instructions.

NOTE

This equipment has been tested and found to comply with the limits for a Class B digital device, pursuant to Part 15 of the FCC Rules. These limits are designed to provide reasonable protection against harmful interference in a residential installation. This equipment generates, uses, and can radiate radio frequency energy and, if not installed and used in accordance with the instructions, may cause harmful interference to radio communications. However, there is no guarantee that interference will not occur in a particular installation. If this equipment does cause harmful interference to radio or television reception, which can be determined by rotating the equipment off and on, the user is encouraged to try to correct the interference using one or more of the following measures:

- Reorient or relocate the receiving antenna.
- Increase the separation between the equipment and receiver.
- Connect the equipment into an outlet on a circuit different from that to which the receiver is connected.
- Consult the dealer or an experienced radio/TV technician for help.

If you have a question about this product, call the Sony Customer Information Center at keep on next line 1-877-760-7669; or write to the Sony Customer Information Center at 12451 Gateway Boulevard, Fort Myers, FL 33913. The number below is for FCC-related matters only.

Declaration of Conformity

Trade Name: SONY

Model No.: PEG-NZ90/U

Responsible Party: Sony Electronics Inc.

Address: 680 Kinderkamack Road, Oradell, NJ 07649 USA

Telephone No.: 201-930-6972

This device complies with part 15 of the FCC Rules.

Operation is subject to the following two conditions:

- (1) This device may not cause harmful interference, and
- (2) This device must accept any interference received, including interference that may cause undesired operation.

The supplied interface cable must be used with the equipment in order to comply with the limits for a digital device pursuant to Subpart B of Part 15 of FCC Rules.

RECYCLING LITHIUM-ION BATTERIES

Lithium-Ion batteries are recyclable.

You can help preserve our environment by returning your used rechargeable batteries to the collection and recycling location nearest you.

For more information regarding recycling of rechargeable batteries, call toll free 1-800-822-8837, or visit

<http://www.rbrc.org/>

Caution: Do not handle damaged or leaking lithium-ion batteries.



IN NO EVENT SHALL SONY BE LIABLE FOR ANY INCIDENTAL, INDIRECT OR CONSEQUENTIAL DAMAGES OR OTHER DAMAGES INCLUDING WITHOUT LIMITATION LOSS OF PROFITS, LOSS OF REVENUE, LOSS OF DATA, LOSS OF USE OF THE PRODUCT OR ANY ASSOCIATED EQUIPMENT, DOWNTIME, AND PURCHASER'S TIME RELATED TO OR ARISING OUT OF THE USE OF THIS PRODUCT, ITS HARDWARE AND/OR ITS SOFTWARE.

On the supplied software

- Copyright laws prohibit reproducing the software or the software manual in whole or in part or renting the software without the permission of the copyright holder.
- In no event will SONY be liable for any financial damage or loss of profits, including claims made by third parties, arising out of the use of the software supplied with this product.
- In the event a problem occurs with this software as a result of defective manufacturing, SONY will replace it at SONY's option or issue a refund. However, SONY bears no other responsibility.
- The software provided with this product cannot be used with equipment other than that which it is designated for use with.
- Please note that, due to continued efforts to improve quality, the software specifications may be changed without notice.
- The software library incorporated in CLIE handheld is based in part on the work of the Independent JPEG Group.

Program © 2002 Sony Corporation, © 2002 Palm, Inc., or its subsidiaries. All rights reserved.
Documentation © 2003 Sony Corporation

CAUTION

Please contact your nearest Sony dealer regarding any problems you are experiencing with your Sony product.

Notes

- Sony does not support third-party add-on applications. If you are having a problem with a third-party application, please contact the developer or publisher of that software.
- The illustrations in this manual may differ from the actual software.
- Explanations in this manual assume that you are familiar with basic operations of Windows®. For how to use your computer and operating system, please refer to their respective manuals.

Before using your CLIE handheld, be sure to read the accompanying End-User's License Agreement.

Sony, CLIE, "Memory Stick", "MagicGate Memory Stick", Jog Dial, PictureGear Studio and their logos are trademarks of Sony Corporation.

Palm OS, Graffiti and HotSync are registered trademarks of Palm, Inc. and its subsidiaries, and Palm, Palm Powered, Palm Desktop, the Palm logo, the Palm Powered logo, the HotSync logo and Palm OS5 logo are trademarks of Palm, Inc and its subsidiaries.

Microsoft and Windows are registered trademarks of Microsoft Corporation.

Pentium is a registered trademark of Intel Corporation.

Pumatech, the Pumatech logo, IntelliSync and IntelliSync Lite are trademarks of Pumatech, Inc., that may be registered in some jurisdictions.

Adobe and Acrobat are trademarks of Adobe Systems Incorporated.

Bluetooth is a trademark that is owned by the proprietor and used by Sony under license.

QuickTime and the QuickTime logo are trademarks of Apple Computer, Inc.

NetFront is a trademark of ACCESS CO, Ltd.

Picisel and the Picisel logo are trademarks of Picisel Technologies, Ltd.

Contains Macromedia® Flash™ Player technology by Macromedia, Inc.,
Copyright © 1995-2001 Macromedia, Inc. All rights reserved.

Macromedia, Flash and Macromedia Flash are trademarks or registered trademarks of Macromedia, Inc. in the United States and internationally.

This product includes fonts owned by TypeBank Co., Ltd. under license.

CompactFlash is a U.S. registered trademark of SanDisk Corporation.

All other trademarks are trademarks of their respective owners.

FCC Radio-Frequency Exposure Statement

This equipment generates and radiates radio-frequency energy. In order to comply with FCC radio-frequency radiation exposure guidelines for an uncontrolled environment, this equipment has to be installed and operated while maintaining a minimum body to antenna distance of 2.5 cm. Based on continuous exposure of 30 minutes.

Users are not permitted to make changes or modify the system in any way.

The term “IC:” before the radio certification number only signifies that Industry Canada technical specifications were met.

Le terme «IC» avant le numéro d’homologation ne signifie seulement que les normes d’Industrie Canada ont été respectées.

This Class B digital apparatus complies with Canadian ICES-003.

Cet appareil numérique de la classe B est conforme à la norme NMB-003 du Canada.

Operation is subject to the following two conditions: (1) this device may not cause interference, and (2) this device must accept any interference, including interference that may cause undesired operation of the device.

L’utilisation de ce dispositif est autorisée seulement aux conditions suivantes: (1) il ne doit pas produire de brouillage et (2) l’utilisateur du dispositif doit être prêt à accepter tout brouillage radioélectrique reçu, même si ce brouillage est susceptible de compromettre le fonctionnement du dispositif.

To prevent radio interference to the licensed service, this device is intended to be operated indoors and away from windows to provide maximum shielding.

Equipment (or its transmit antenna) that is installed outdoors is subject to licensing.

Pour empêcher que cet appareil cause du brouillage au service faisant l’objet d’une licence, il doit être utilisé à l’intérieur et devrait être placé loin des fenêtres afin de fournir un écran de blindage maximal. Si le matériel (ou son antenne d’émission) est installé à l’extérieur, il doit faire l’objet d’une licence.

WARNING

- **The Bluetooth™ function equipped with CLIÉ handheld is valid only in those countries where CLIÉ handheld is sold.**
- In some situations or environments, the use of the Bluetooth™ technology might be restricted by the proprietor of the building or responsible representatives of the organization, for example on board of airplanes, in hospitals or in any other environment where the risk of interference with other devices or services is perceived or identified as harmful.
- If you are uncertain about the policy applying to the use of Bluetooth™ technology in a specific organization or environment, you are encouraged to first ask for authorization prior to switching it on.
- Consult your physician or the manufacturer of personal medical devices (pacemakers, hearing aids, etc.) regarding any restrictions on the use of Bluetooth™ technology.
- To disable the Bluetooth™ function, turn off your CLIÉ handheld (page 31).

Recycling the Battery Pack (Lithium-Ion battery)

The supplied Battery Pack (Lithium-Ion battery) is recyclable.

You can help preserve our environment by returning your used Lithium-Ion batteries to the collection and recycling location nearest you.

For more information regarding recycling of rechargeable batteries, call toll free 1-800-822-8837, or visit the website (<http://www.rbrc.org/>).

When you dispose of a CLIÉ handheld, remove the battery for recycling.

How to remove the Battery Pack (Lithium-Ion battery)

Follow “Inserting/Replacing the battery” (page 19) to remove the battery.

How to remove a rechargeable button battery

- 1** Remove the screw from the side of your CLIÉ handheld with a Phillips screwdriver.
- 2** Remove the battery cover.

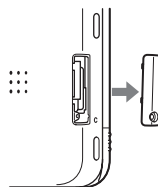
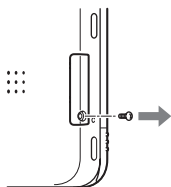

- 3** Pull the ribbon attached to the button battery.
- 4** Pull the button battery and disconnect it from your CLIÉ handheld.

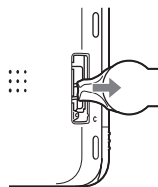
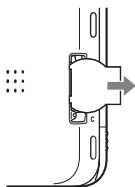

Table of Contents

Checking the package contents 10

Sony CLIE™ handheld components. 12

Locating the parts of your Sony CLIE handheld	12
Changing the operating style	15
Locating cradle components	17
Locating the controls on the supplied audio remote control	18

Charging your Sony CLIE™ handheld. 19

Step 1: Inserting/Replacing the battery	19
Step 2: Charging the battery	21

Performing the initial settings 23

Basic operations of your Sony CLIE™ handheld. 29

Basic operations	29
Functions of parts	31
Restarting your Sony CLIE handheld	40
Locating the components of the initial screen.	43
Using applications	47
Entering data.	49

Taking images/movies. 50

Taking images	50
Recording movies	61

Viewing/Playing back files (CLIE Viewer)	63
--	----

Using your CLIE™ handheld with your computer 65

Step 1: Install the software on your computer.	65
Step 2: Connect the cradle to your computer.	68
Step 3: Enter a user name for your CLIE handheld.	69
Synchronizing data between your CLIE handheld and computer (HotSync®)	71

Enjoying your CLIE™ handheld 73

Using your CLIE handheld to view image files and movie files taken with "Memory Stick"-compliant devices	73
Using voice recorder	74
Listening to music	75
Managing schedules (Date Book)	76
Managing addresses and telephone numbers (Address)	78
Exchanging Date Book and Address data between your CLIE handheld and computer.	79
Viewing computer documents on your CLIE handheld (PicSel Viewer for CLIE)	80
Connecting to the Internet	81
Using the Bluetooth™ function	82

Using applications	86
Using CLIÉ Application Manual	86
Installing add-on applications on your CLIÉ handheld	88
Introducing add-on applications	89

Troubleshooting.	101
Preventing problems	101
Solving problems	102
Getting Help.	103

Additional information . . .	104
Notes on use	104
Specifications	107
INDEX	112

Notes on this manual

- Screen pictures in this manual may be different from the actual displays in the supplied software.
- Contents of this manual are written for users with knowledge of using Microsoft® Windows® operating system. For details about computer operation, refer to the manual for the computer.

About display (LCD) and camera lens

The LCD of your CLIÉ handheld is designed with precision technology. However, some pixels may not work or may light always in some cases. Also, brightness of the display may be inconsistent depending on the angle of view. These are caused by the nature of the LCD and do not indicate a malfunction.

Please note that Sony does not guarantee for replacement or return in cases like those. Do not keep the LCD or camera lens directed toward the sun for long time. It may cause a malfunction. Please be careful when you locate it at an outdoor environment or place next to a window.

Testing for taking pictures/movies and recording voices

Prior to taking pictures/movies and recording voices, check that those files are normally saved in your CLIÉ handheld or a “Memory Stick” media.

No guarantee for lost data or damaged data

Sony does not provide any guarantee for lost data or damaged data caused by improper operations.

Copyrights

Television programs, films, video tapes, and other materials may be copyrighted. Unauthorized recording of such materials may be contrary to the provision of the copyright laws.

Checking the package contents

Please check the accessories in the package before you start.

CLIE handheld (1)

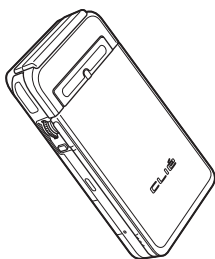

Cradle (1)

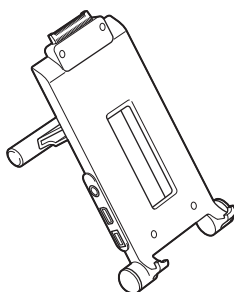

AC power adapter (1)

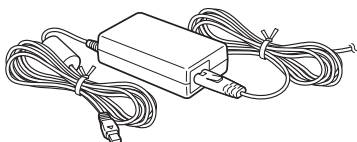

Headphones (1)



Stylus (1)



The stylus is stored in your CLIE handheld at the factory.

Audio remote control (1)

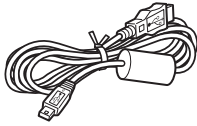
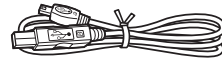
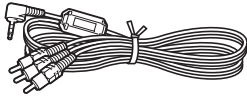
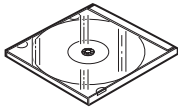

USB cable (1)**Printer cable (1)****AV cable (1)****Battery Pack (1)****Installation CD-ROM****Strap (1)**

Refer to the illustration below to attach the strap.

Protection card (1)

The protection card is stored in your CLIÉ handheld at the factory.

Read This First - Operating Instructions (1, this manual)**Troubleshooting Q&A (1)****Customer Registration Guide (1)****Customer Registration card (Warranty)****Graffiti label (1)****Software license agreement (1)****Other printed materials**

Make sure that the package contains all of the listed accessories. If any item is missing, contact the Sony Customer Information Service Center or a Sony dealer.

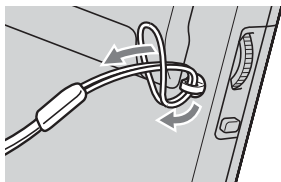
Attaching the strap

Sony CLIÉ™ handheld components

Each part of the CLIÉ handheld and the supplied accessories is explained in the following.

Locating the parts of your Sony CLIÉ handheld

.....
Front panel

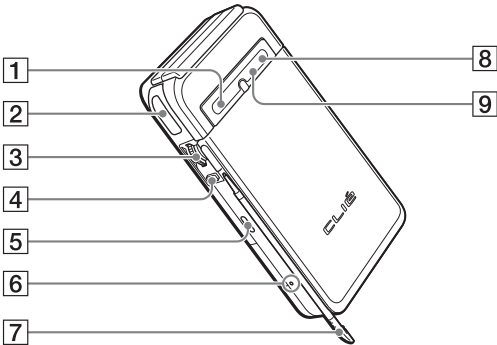

1 POWER LED (Page 32)

2 IR port (Page 35)

**3 Jog Dial™ navigator
(Page 30)**

4 BACK Button (Page 34)

**5 VOICE REC Button
(Page 33, 74)**

6 RESET Button (Page 40)

7 Stylus (Page 29)

8 Bluetooth LED (Page 82)

**9 "Memory Stick" LED
(Page 36)**

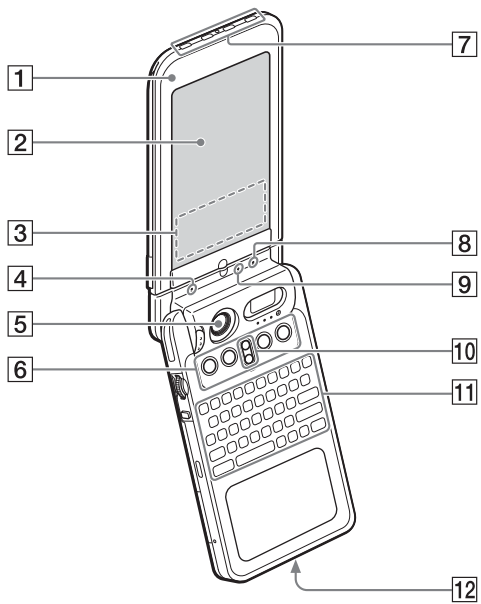

- 1 Display Panel (Page 15)**
- 2 Screen (Page 43)**
- 3 Graffiti Writing Area (Page 43)**
- 4 POWER LED (Page 32)**
- 5 Camera Lens Cover (Page 33)**
- 6 Application Buttons (Page 48)**
- 7 Application Buttons (Page 48)**
- 8 Bluetooth LED (Page 82)**
- 9 "Memory Stick" LED (Page 36)**
- 10 Scroll Button (Page 35)**
- 11 Hardware Keyboard (Page 37)**
- 12 Wireless Communication Slot (Page 38)**

Available only when your CLIE handheld is set to the turned style.

.....

Back panel

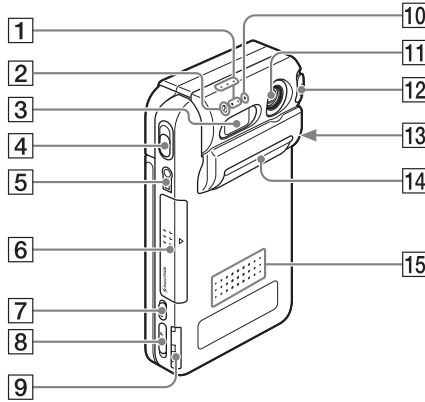

- 1 Microphone (Page 74)**
- 2 Flash Photometric Sensor**
- 3 Flash (Page 58)**
- 4 CAPTURE Button
(Page 32, 50, 52, 62)**
- 5 Headphone Jack (Page 75)**
- 6 Battery Cover (Page 19)**
- 7 HOLD Switch (Page 34)**
- 8 POWER Switch (Page 31)**
- 9 "Memory Stick" Slot
(Page 36)**
- 10 REC LED (Page 33)**
- 11 Camera Lens (Page 33)**
- 12 Lens Cover Lever (Page 33)**
- 13 Strap Hook (Page 11)**
- 14 Interface Connector Cover
(Page 22)**
- 15 Speaker (Page 45)**

Changing the operating style

Your CLIE handheld can be used with the display panel set in three different styles.

Carrying style

Set your CLIE handheld to the “carrying style,” when carrying it around in your baggage or pocket to guard the screen from damage.

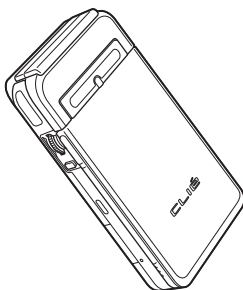

Opened style

Set your CLIE handheld to the “opened style,” when you enter data with the hardware keyboard or take images/movies of yourself.

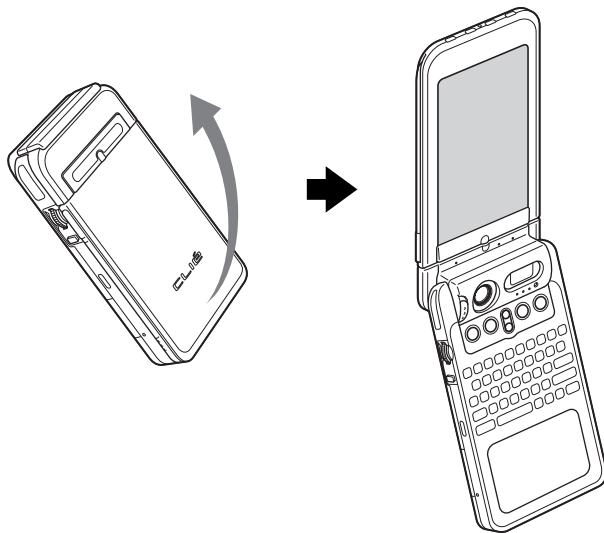

Open the display panel until it clicks into place.

Turned style

Set your CLIÉ handheld to “turned style” to make it compact when you operate it with the Stylus or use it in the Camera mode.

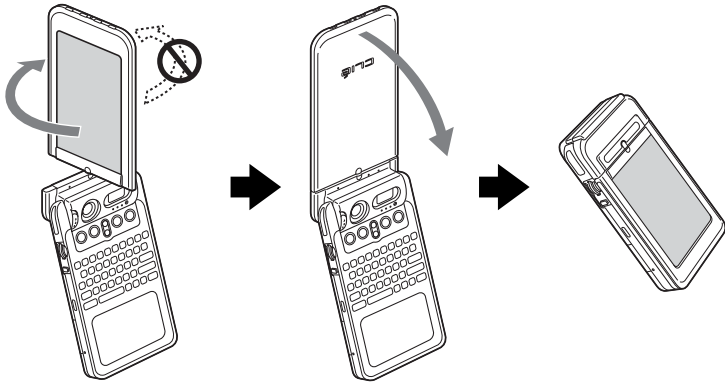

Open the display and rotate it as indicated by an arrow until it clicks into place

Fold the display over the keyboard

Note

Do not turn the display panel in any direction other than that specified and do not apply too much force.

Closing the display panel

Close the display panel by rotating it as indicated by an arrow.

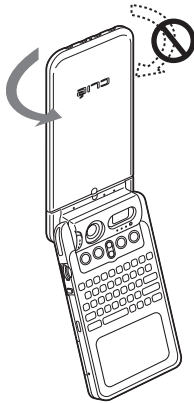

Locating cradle components

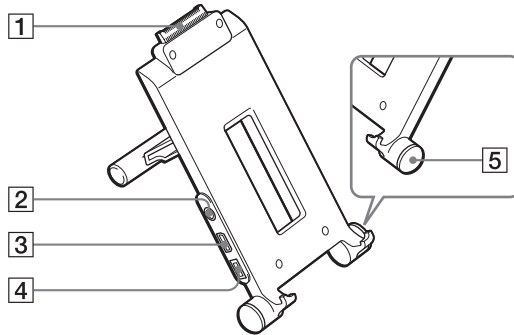

**1 Interface Connector
(Page 22)**

2 AV output jack

You can connect the supplied AV cable to view the screen of “CLIE Album” with your television (page 90).

3 USB Cable Connector

You can connect the supplied USB cable to connect the cradle and your computer (page 68). You can also connect the supplied printer cable to print out the contents of the “CLIE Album” screen or “CLIE Viewer” screen with your printer.

**4 AC Adapter Connector
(Page 21)**

5 HotSync Button (Page 69, 72)

Locating the controls on the supplied audio remote control

You can use the audio remote control when you play back music or audio movies with an application such as Audio Player or Movie Player.

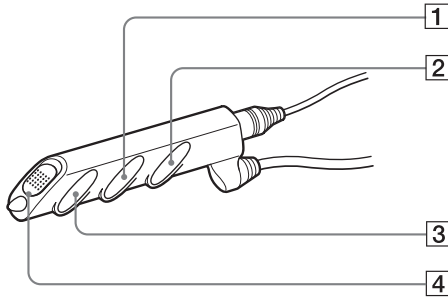

1 **⏪/⏩ Button**

2 **Volume Control Button**

3 **▶/■ Button**

4 **HOLD Switch**

➔ For details on operating each application, refer to the “CLIE Application Manual” installed on your computer.

Charging your Sony CLIÉ™ handheld

Before you use your CLIÉ handheld for the first time, insert the supplied Battery Pack into your CLIÉ handheld and be sure to charge the battery.

Step 1: Inserting/Replacing the battery

When you replace the battery, be sure to turn off your CLIÉ handheld and check that the POWER LED and "Memory Stick" LED are off prior to opening the battery cover.

If you open the battery cover while the power is on, data stored on your CLIÉ handheld or data being recorded to a "Memory Stick" media may be deleted.

1 Open the battery cover.

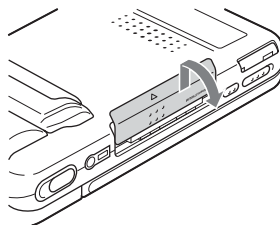

2 Insert the battery.
You can easily insert the battery by sliding the battery release knob with the tip of the battery.

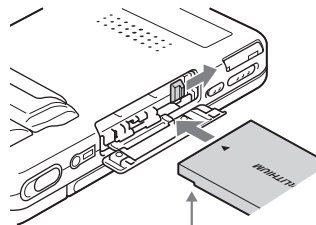

Face the battery terminal towards the display panel side

Continued on next page

- 3** Close the battery cover.
Verify that the battery is completely inserted into the slot and close the battery cover.

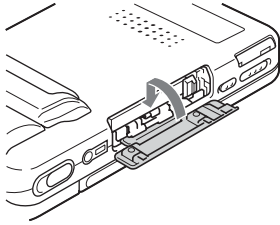

Removing the battery

Slide the battery release knob as directed by the arrow and remove the battery.

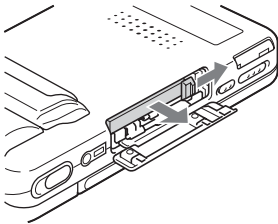

Tip

About the built-in rechargeable button battery

Your CLIÉ handheld uses the built-in rechargeable button battery to maintain data stored in the built-in memory while replacing the Battery Pack.

The rechargeable button battery is automatically charged while you use your CLIÉ handheld. However, the rechargeable button battery will be completely discharged in approximately twelve hours if the power is not supplied from the Battery Pack. Make sure you recharge the button battery before it gets completely discharged.

How to charge the rechargeable button battery

- Place your CLIÉ handheld in the cradle while the Battery Pack is inserted.
- Turn off your CLIÉ handheld for 24 hours or more while the charged Battery Pack is inserted.

About the Battery Pack

■ Supplied Battery Pack

The “Smart Lithium” function enables to exchange information about battery conditions between your CLIE handheld and the Battery Pack. Your CLIE handheld calculates the discharge rate according to the battery condition and displays the battery’s remaining charge on the minute time scale (page 44).

■ Remaining charge indicator

If the battery runs out quickly while sufficient remaining charge is read in the display, recharge the battery fully to correct a misreading. However, this operation may not work in the following cases.

- You use the battery at a high temperature for a long time.
- You leave the fully-charged battery for a long time.
- The battery has been worn-out .

■ Operating life

The efficiency of a battery is gradually reduced as the battery is charged or time go on. If the operation time of your battery becomes shortened notably, you may need a new one.

The operating life of your Battery Pack varies depending on storage environments, operating environments, and battery model.

Step 2: Charging the battery

- 1** Set up the stand of the cradle.

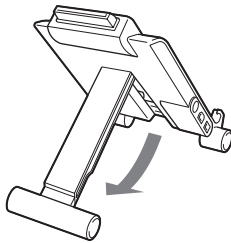

- 2** Connect the AC adapter to the cradle.

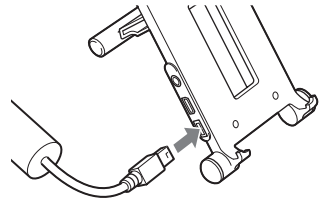

- 3** Connect the AC adapter to a wall outlet.

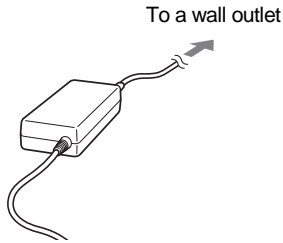

- 4** Open the interface connector cover of your CLIÉ handheld.

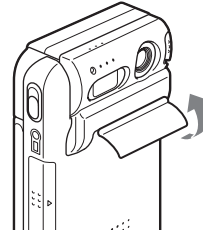

- 5** Insert your CLIÉ handheld at an angle into the cradle and lay it back to fit into place. The POWER LED indicator of your CLIÉ handheld turns on and charging starts.

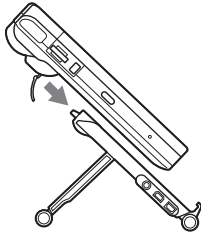

It takes about four hours for your CLIÉ handheld to be fully charged for the first time. The POWER LED indicator of your CLIÉ handheld turns off when charging is completed.

Tip

If your CLIÉ handheld is charged frequently, subsequent charges will require less time.

Notes

- If the battery in your CLIÉ handheld is fully discharged, all data stored in the memory on your CLIÉ handheld will be lost.
- Insert your CLIÉ handheld into the cradle completely until the POWER LED indicator of your CLIÉ handheld turns on.
- When you remove your CLIÉ handheld from the cradle, hold the stand of the cradle.

Performing the initial settings

The first time you turn on your CLIÉ handheld, you are required to make initial settings. Follow the on-screen instructions to configure the initial settings and to get accustomed to operations on your CLIÉ handheld.

1 Slide the POWER switch.

Your CLIÉ handheld turns on, and the **Welcome** screen is displayed.

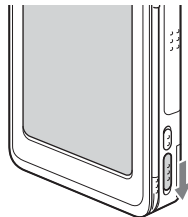

Slide the POWER switch

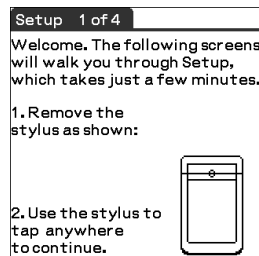

Tip

If you cannot turn on your CLIÉ handheld

- Is the HOLD switch (page 34) set to HOLD?
- Did you charge your CLIÉ handheld following the steps on page 19?
- ➔ For details, refer to the supplied manual “Troubleshooting Q&A.”

- If you cannot turn on your CLIÉ handheld even after charging it, perform a soft reset (page 40).

- 2** Take out the Stylus.
You can use the stylus to enter data or to select applications.

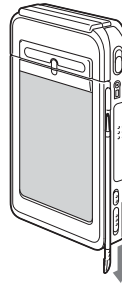

Take out the Stylus

Notes

- Always use the point of the stylus for tapping or making strokes on the CLiÉ handheld screen. Never use a real pen, pencil, or other sharp object to write on the screen.
- When you put the stylus back in its holder, push it in until it clicks into place.

- 3** Press lightly on the screen with the stylus.
This action is called “tapping.”

The **Setup** screen for digitizer calibration is displayed.

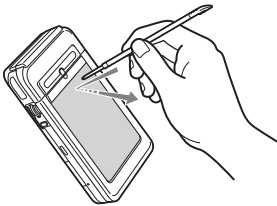

Press lightly on the screen (Tap)

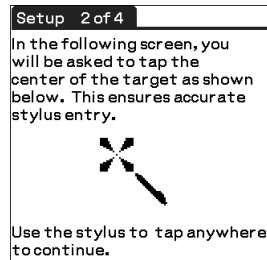

4 Following the on-screen instruction, tap the center of the displayed mark.

Note

If the digitizer is not configured correctly, the scroll bar may not operate properly, “tapping” may not work as expected, or other problems may occur. For re-configuring the digitizer, refer to “Customizing your Sony CLIÉ handheld (Preferences): Adjusting the digitizer” in the “Handbook.”

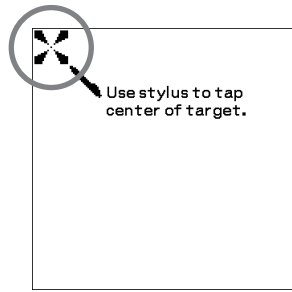

After calibration is completed, a screen for setting the time and date appears.

5 Tap the **Set Time** box. The **Set Time** screen is displayed.

Tip

You can reconfigure the date and time settings in the **Preferences** screen.

➔ For details, refer to “Setting the Date & Time preferences” in the “Handbook.”



6 Tap the arrow ▲ or ▼ to set the current time.

Tap each box to set the current hour and minute.



7 Tap **OK**.

The current time is set and the **Setup** screen is displayed.

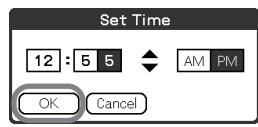

- 8** Tap the **Set Date** box.
The **Set Date** screen is displayed.

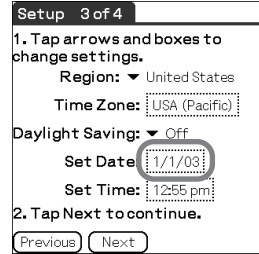

- 9** Tap the arrow ◀ or ▶ next to the year to select the current year.

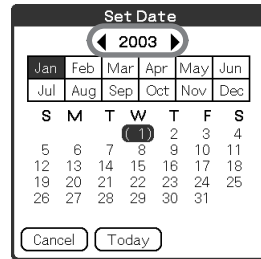

- 10** Tap the current month and then tap the current date.
The **Set Date** screen closes.

- 11** Tap the **Time Zone** box.
The **Set Time Zone** screen is displayed.

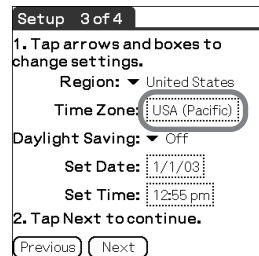

12 Tap the region to set the time zone and then tap **OK**.



13 Tap the arrow ▼ next to **Daylight Saving** and select **ON** or **OFF**.



14 Tap **Next**.

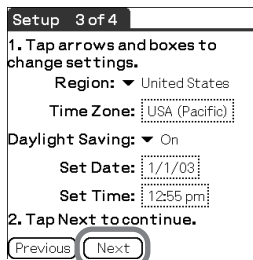

15 Tap **Next** and **Done**.

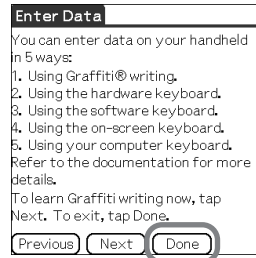
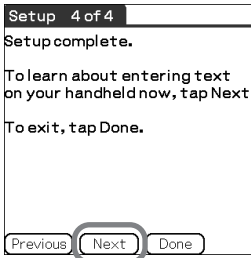

The initial settings are complete, and the CLIE Launcher screen is displayed.

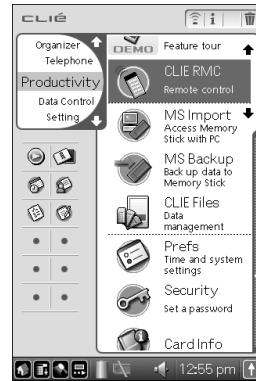

Initial settings are complete.

Basic operations of your Sony CLIÉ™ handheld

This chapter describes how to start applications, enter data, and perform other basic operations.

Basic operations

Using the stylus

With your CLIÉ handheld, you can use the supplied stylus to enter characters or specify an application you want to run.

Taking out the stylus

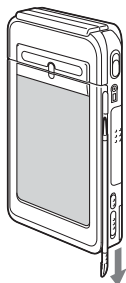

The stylus is stored in the holder on the display panel of your CLIÉ handheld.

Note

To avoid losing the stylus, always put it back in its holder after use.

Tapping

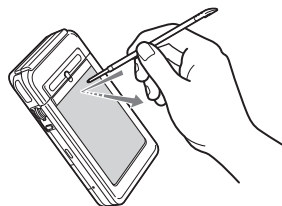

The action of pressing lightly on the screen with the stylus is called “tapping.”

Continued on next page

Dragging

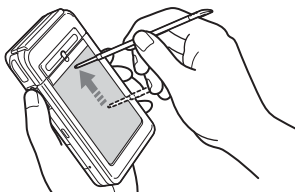

Just as you can drag the mouse to select (and drag) text or move objects on your computer, you can use the stylus to drag an item on the screen of your CLIÉ handheld. Press the stylus lightly on the item, and move it along the screen surface.

Using the Jog Dial™ navigator

Your CLIÉ handheld is equipped with a Jog Dial™ navigator, which allows you to perform all major operations without the stylus. You can operate your CLIÉ handheld using the Jog Dial™ navigator with just one hand.

Rotating the Jog Dial™ navigator

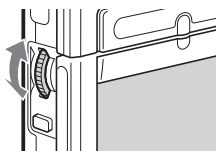

Rotate the Jog Dial™ navigator to select various items or to select an application to start.

Pressing the Jog Dial™ navigator

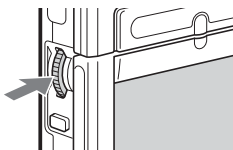

Press the Jog Dial™ navigator to decide the selected item or to run the selected application.

Rotating while holding down the Jog Dial™ navigator

Some applications support operations executed by rotating while pressing the Jog Dial™ navigator.

Functions of parts

POWER Switch

Turning on your CLIÉ handheld

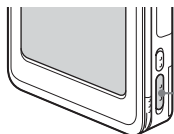

Slide the POWER switch.

Your CLIÉ handheld turns on and the last screen you viewed is displayed.

When your CLIÉ handheld turns on, the POWER LED (page 32) indicator lights green.

Tip

When you turn on your CLIÉ handheld for the first time, the **Welcome** screen is displayed (page 23).

Note

If you cannot turn on your CLIÉ handheld, make sure that if the HOLD switch is not in the HOLD position.

If you try to turn on your CLIÉ handheld while the HOLD switch is in the HOLD position, the POWER LED indicator blinks green three times.

Turning off your CLIÉ handheld

Slide the POWER switch again.

Tip

You do not have to save data, quit an application, or perform any of the other shutdown procedures that your computer requires.

Sliding the POWER switch for more than two seconds

You can switch on/off the backlight of the LCD.

POWER LED

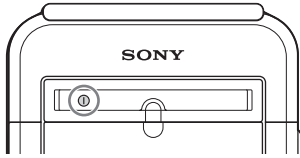

Carrying style
Opened style

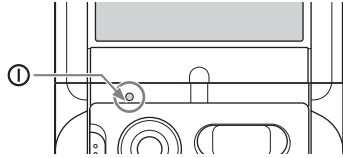

Turned style

The LED indicator shows the status of your CLIÉ handheld by its color.

LED	The status of your CLIÉ handheld
Lights green	The power is ON.
Lights orange	The battery is being charged.
Blinks orange	Alarm notifies you at a given time if you have made an alarm setting in an application, such as Date Book.
Blinks green (three times)	The HOLD switch is in the HOLD position (blinks when you try to turn on your CLIÉ handheld).
OFF	The power is OFF.

CAPTURE Button

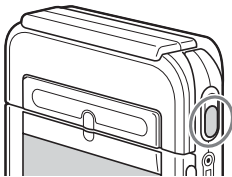

Press the button to take images or movies.

➔ For details, refer to “Taking images/movies” on page 50.

.....

Camera

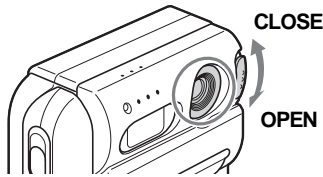

You can take still images or movies.

Note

When the camera is not in use, close the lens cover by sliding the lens cover lever to the “CLOSE” position.

► For details, refer to “Taking images/movies” on page 50.

.....

REC LED

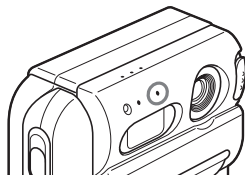

Lights when you are recording a movie or voice memo.

► For details, refer to the explanation of each application in the “CLIÉ Application Manual” installed on your computer.

.....

VOICE REC Button



Press the button to record sounds.

► For details, refer to “Using voice recorder” on page 74.

HOLD Switch

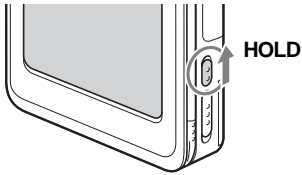

Protects your CLIÉ handheld from accidental tapping on the screen or pressure on the POWER switch when you are carrying your CLIÉ handheld. If you slide this switch while the power is on, the screen display turns off, even during an operation.

Note

If you cannot turn on or operate your CLIÉ handheld, check if the HOLD switch is not in the HOLD position.

If you try to turn on your CLIÉ handheld while the HOLD switch is in the HOLD position, the POWER LED indicator blinks green three times.

BACK Button

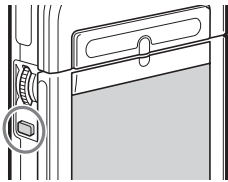

Cancels the selection of an item and cancels the operation. Depending on the application, unique features such as restoring to the previous screen are assigned.

Tip

Press the BACK button for a few seconds to switch to the CLIE Launcher screen.

➔ For details, refer to the explanation of each application in the “CLIÉ Application Manual” installed on your computer.

Scroll Button

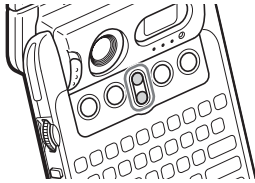

Displays text and other information that extends beyond the area of the screen. Pushing the ▼ button scrolls down to display information below the current viewing area, and pushing the ▲ button scrolls up to display the information above the current viewing area. Depending on the application, unique features are assigned.

- For details, refer to the explanation of each application in the “CLIÉ Application Manual” installed on your computer.

IR port

You can beam data between your CLIÉ handheld and another CLIÉ handheld or Palm OS® PDA.

- For details, refer to “Beaming” in the “Handbook.”

Direct your CLIÉ handheld towards a target device as indicated by an arrow when using the remote control function.

* Move your CLIÉ handheld gradually to find the most sensitive direction.

Direct your CLIÉ handheld towards a target device as indicated by an arrow when using the beaming function.

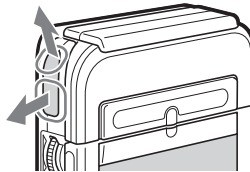

Tip

You can also use your CLIÉ handheld as a remote control with the CLIE Remote Commander application.

- For details, refer to the “CLIÉ Application Manual” installed on your computer.

“Memory Stick” Slot

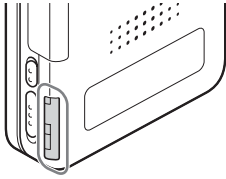

Insert “Memory Stick” media into this slot.

The “Memory Stick” LED blinks orange while your CLIÉ handheld is writing data to or reading data from “Memory Stick” media.

► For details, refer to “Using “Memory Stick®” media” in the “Handbook.”

Inserting “Memory Stick” media

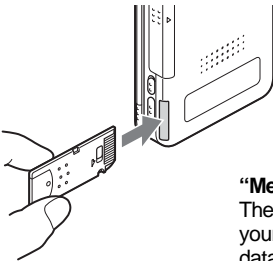

“Memory Stick” LED

The “Memory Stick” LED blinks orange while your CLIÉ handheld is writing to or reading data from “Memory Stick” media.

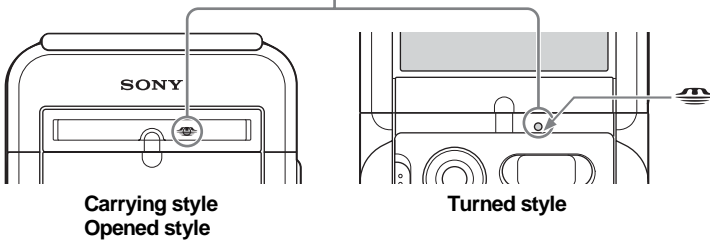

Notes

- Insert “Memory Stick” media in the right direction. If “Memory Stick” media is forcibly inserted in the wrong direction, the “Memory Stick” slot may be damaged.
- Do not insert “Memory Stick” media other than the “Memory Stick” slot.

Removing "Memory Stick" media

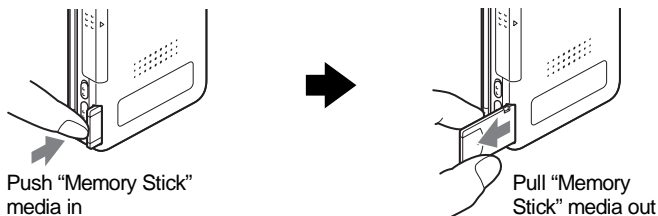

Note

Make sure that your CLIE handheld is not writing to or reading data from "Memory Stick" media (the "Memory Stick" LED is not blinking) before removing it. If you remove "Memory Stick" media while the "Memory Stick" LED is blinking, recorded data may be deleted or damaged.

Hardware Keyboard



You can use the hardware keyboard in the same way as with the keyboard of your computer. This is useful when you want to enter lots of data.

Input commands list

You can carry out commands using the hardware keys in combination.

Key combinations

Example: Ctrl+C → Hold down the Ctrl key and press the key of the character C.

Combination	Function
Fn + character	Enter the numbers and marks printed in blue.
Shift + character	Enter letters in upper case when "Caps" is off.
Shift + ►/◀	Selects a continuing/preceding text.
Shift + Ctrl + ◀	Selects until the first letter of the text.
Shift + Ctrl + ►	Selects until the last letter of the text.
Ctrl + C	Copies the selected text.
Ctrl + X	Cuts the selected text.

Continued on next page

Ctrl + V	Pastes the selected text.
Ctrl + D	Deletes the selected text.
Ctrl + L	Turns the backlight on and off.
Ctrl + H	Switches to the CLIE Launcher screen.
Ctrl + M	Displays the menu.
Ctrl + F	Opens the Find dialog box.
Ctrl + ▲	Same as rotating the Jog Dial™ navigator upwards.
Ctrl + ▼	Same as rotating the Jog Dial™ navigator downwards.
Ctrl + ←	Same as pressing the Jog Dial™ navigator.
Ctrl + ← and hold	Same as keeping the Jog Dial™ navigator pressed.
Ctrl + BS	Same as pressing the BACK button.
Ctrl + BS and hold	Same as keeping the BACK button pressed.
Ctrl + Shift + ▲	Same as rotating the Jog Dial™ navigator upwards while pressing it.
Ctrl + Shift + ▼	Same as rotating the Jog Dial™ navigator downwards while pressing it.
Ctrl + Tab	Jumps to the next field.
Ctrl + Shift + Tab	Jumps back to the previous field.

..... Wireless Communication Slot

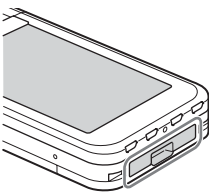

You can connect to the Internet by using the compact flash type data network card (from this point, referred to as network card).

- For details, refer to “Connecting to the Internet” on page 81.
- For details about an operation confirmed network card, refer to “Operation confirmed network card” on page 110.

Notes

- Only the compact flash type data network card can be inserted into the wireless communication slot. Network cards or memory cards other than the above-mentioned will not work. Do not use any other card in your CLIE handheld, as it may cause a malfunction.
- If your CLIE handheld is not working properly, remove the network card once, and insert the network card again.
- There may be some data network services that may not be used, depending on the network card and provider that you are using. For details, refer to the operating instructions of your network card or contact your Internet service provider.

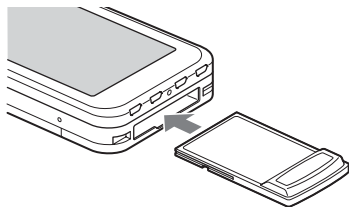
Inserting the network card**Tip**

The protection card is inserted into the wireless communication slot at the factory.

Note

Do not insert the network card forcibly in the wrong direction or at the wrong angle. It may cause a malfunction or damage your CLIE handheld.

Removing the network card

Make sure that your CLIE handheld is turned off prior to removing the network card.

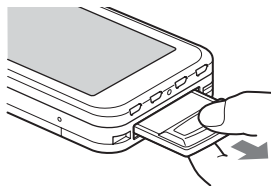
**Notes**

- Do not remove the network card while it is connected to the Internet. It may cause a malfunction.
- When the wireless communication slot is empty, always insert the protection card to protect the slot.
- Do not remove the network card forcibly in the wrong direction or at the wrong angle. It may cause a malfunction, or damage your CLIE handheld or network card.

Restarting your Sony CLIÉ handheld

Normally, you do not need to reset your CLIÉ handheld. However, should your CLIÉ handheld not turn on or not respond, you can perform a soft reset to solve the problem.

Follow the procedure below to reset your CLIÉ handheld.

.....

Performing a soft reset

All records and entries stored in your CLIÉ handheld are retained even after performing a soft reset.

- 1 Take out the stylus pin by unscrewing the metal barrel from the stylus quill.

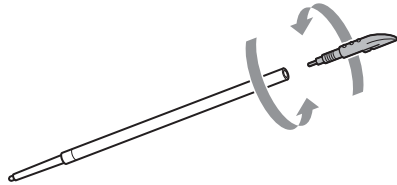

- 2 Use the stylus pin to gently press the RESET button. The system shuts down and then restarts. After restarting, the system displays “palm powered,” “CLIÉ,” and “SONY,” followed by the **Preferences** screen for setting the time and date.

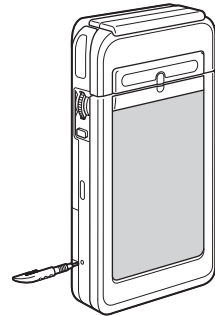

Notes

- After the RESET button is pressed, it takes a while until the **Preferences** screen is displayed. Be sure not to press the RESET button again while resetting.
- Do not press the RESET button with a tool other than the stylus pin. It may cause a malfunction.

Performing a hard reset

If the soft reset does not solve the problem, you need to perform a hard reset to restart your CLIÉ handheld.

Notes

- **All records and add-on applications stored in your CLIÉ handheld will be erased by performing a hard reset.**
- Perform a hard reset only if a soft reset does not solve your problem. You can restore your CLIÉ handheld data if you have made a backup on your computer or “Memory Stick” media.
 - ➔ For details, refer to “Backing up your Sony CLIÉ™ handheld data” in the “Handbook.”

- 1 Slide the POWER switch.
- 2 While sliding the POWER switch, press the RESET button gently with the stylus pin.

Press the RESET button with the stylus pin as illustrated on page 40

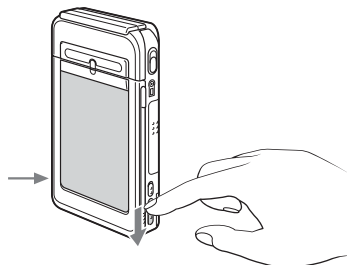

- 3 When the **palm powered** screen is displayed, release the POWER switch after three seconds. A message warning that you are about to erase all the data stored on your CLIÉ handheld is displayed.

- 4 Press the ▲ button on the keyboard panel of your CLIÉ handheld.

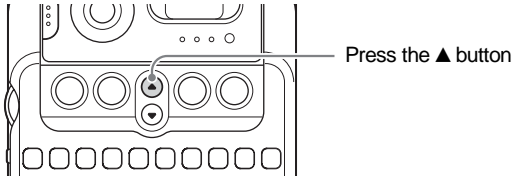

A hard reset is performed on your CLIÉ handheld.

After restarting, the system displays “palm powered,” “CLIÉ,” and “SONY,” followed by the **Welcome** screen. Refer to “Performing the initial settings” on page 23.

After a hard reset, only the current date and time are retained. Formats, Preferences, and other settings are restored to the factory settings.

Notes

- After the RESET button is pressed, it takes a while until the **Welcome** screen is displayed. Be sure not to press the RESET button again while resetting.
- If the ▲ button is not pressed for long enough, the hard reset may not be performed.

Locating the components of the initial screen

Tip

If a different screen is displayed, tap the Home  icon.

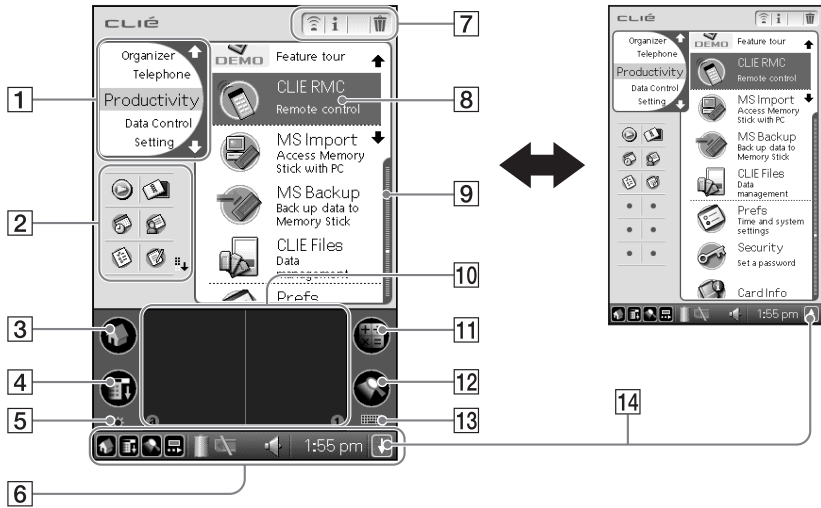

1 CLIE Launcher Groups List

The list of CLIE Launcher groups is displayed.

2 Favorite Applications (shortcuts)

You can create shortcuts to favorite applications.

3 Home Icon

If you tap this icon, the Application Launcher (List of applications) screen will be displayed.

4 Menu Icon

If you tap this icon, the menu of the current application will be displayed.

5 Brightness Adjustment Icon (page 45)

6 Status Bar (page 44)

7 Application Manager Icons (page 46)

8 Application Icons (page 47)

9 Position Indicator

10 Graffiti® Writing Area

This is the area for manually entering data with Graffiti® characters.

11 Calculator (page 96)

If you tap this icon, the on-screen Calculator will be displayed.

12 Find Icon

If you tap this icon, the Find dialog box will be displayed.

13 Graffiti/Software Keyboard Icon (page 46)

14 Resize Icon

If you tap this icon, the screen view will be switched.

Status Bar



The status bar displays the following icons for all applications. Additional icons appear according to the applications in use.

 Tap this icon to display the CLIE Launcher screen.

 Tap this icon to display the menus of the current application.



 Tap this icon to open the **Find** dialog box.

 Tap this icon to display the **Silk Plug-In** dialog box.

If the Silk Plug-In is installed, you can edit the display and functions of the Silk Screen area by switching the Silk Plug-In.



Silk Screen area

 Displays the battery's remaining charge. The  icon is displayed while the battery is being charged.

Tap this icon to display the **Battery Information** dialog box.

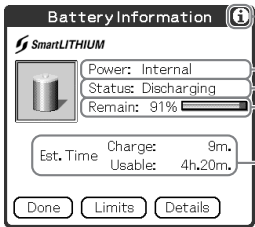



- Information display icon
- Power used
- Battery status
- Remaining charge of the battery
- Estimated time for charging and operation

 Tap this icon to display the information for the “Memory Stick” media inserted in your CLIE handheld.

When the Data Protection switch of the “Memory Stick” media is in the “Lock” position, the  icon is displayed.

When you insert a “Memory Stick”-type device in your CLIE handheld, the  icon is displayed.

When the “Memory Stick” media cannot be read normally, the  icon is displayed.

When the “Memory Stick” slot of your CLIE handheld is empty, the  icon is displayed.



Tap this icon to display the **Adjust Volume** dialog box.

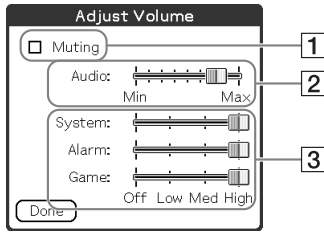

- 1 Turns off the sound of your CLIE handheld irrespective of the volume level setting.

While the Muting mode is selected, the  icon is displayed in the status bar.

- 2 Adjusts the volume level for playback sound of audio files or movie files.

- 3 Adjusts the volume level for System sound, Alarm sound, and Game sound. The setting affects the **General** in the **Preferences**.

➔ For details, refer to “Customizing your Sony CLIE handheld (Preferences): Setting sounds” in the “Handbook.”



Displays the current time. To change the display format, tap **Time** at the **Formats** in the **Preferences**.

➔ For details, refer to “Customizing your Sony CLIE handheld (Preferences): Setting the Date & Time preferences” in the “Handbook.”



Tap this icon to show or hide the Graffiti writing area (for Graffiti-compatible applications only).

Brightness Adjustment Icon



Tap this icon to adjust the brightness level of your CLIE handheld's LCD screen.

Note

If the digitizer preferences are not set correctly, you may have difficulty in tapping.

➔ For details, refer to “Customizing your Sony CLIE handheld (Preferences): Adjusting the Digitizer” in the “Handbook.”

Application Manager Icons



You can manage your applications with the application manager icons.

The followings are featured as standard functions.

 : Beam, Send

 : Info

 : Delete

- ➔ For details, refer to “Sony CLIE™ handheld basic operations: Using “CLIE Launcher”: Application manager icon” in the “Handbook.”

Tip

Application manager functions may be added when you install certain applications.

Icons for switching the Graffiti/Software Keyboard



You can switch between the Graffiti writing area and the software keyboard by tapping this icon.

The software keyboard is much like as the on-screen keyboard, however the applications can be used without minimizing the current screen.

Tip

To switch the software keyboard display

You can switch the keyboard display by tapping the following icons:

 : The alphanumeric keyboard

 : The international keyboard

 : The symbol keyboard

Using applications

Your CLIE handheld can carry out various functions through applications.

Starting an application using the Jog Dial™ navigator

- 1 Tap the Home  icon to display the CLIE Launcher screen.
- 2 Rotate the Jog Dial™ navigator to select an application icon and press it to start.

Tip

You can also tap the desired application icon in the CLIE Launcher screen to start the application.

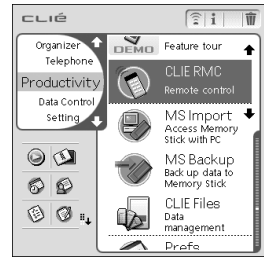

- ➔ For details, refer to “Sony CLIE™ handheld basic operations: Starting an application” or “Sony CLIE™ handheld basic operations: Using ‘CLIE Launcher’” in the “Handbook.”

Starting an application using the application buttons

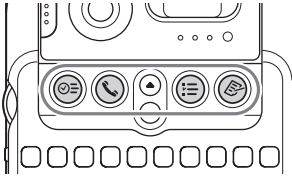

Main body side

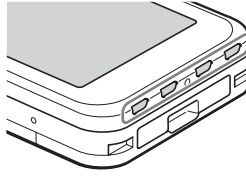

Display panel side

You can press the application button to start an application. By default, the application buttons are set to start Date Book, Address, To Do, and Memo Pad as the icons on each button show.

Note

Application Buttons on the display panel side are available only when your CLIÉ handheld is set to the turned style (page 16).

Tips

- Even when your CLIÉ handheld is turned off, pressing an application button turns on your CLIÉ handheld to start an application.
- You can assign your desired application to each application button.
- For details, refer to “Customizing your Sony CLIÉ handheld (Preferences): Assigning applications to application buttons” in the “Handbook.”

Quitting an application and opening another application

You can only operate one application at a time on your CLIÉ handheld. When you start another application, the previous application automatically closes, therefore you do not need to quit an application.

To open an application when another application has been already started, tap the Home  icon or press the application button.

Tip

You do not need to manually save data when you quit an application. All the changes in the application that you are working on are automatically saved.

Note

For some applications, you need to operate **Finish** or **Save**.

- For details, refer to the “CLIÉ Application Manual” installed on your computer.

Entering data

..... Entering data

There are five ways to enter data on your CLIÉ handheld. Select the one that best suits you.

● **Hardware keyboard (page 37)**

You can enter data using the hardware keyboard in the same way as with the keyboard of your computer. This is useful when you want to enter lots of data.

● **On-screen keyboard**

You can enter data by tapping the keyboard that appears on the screen.

➔ For details on entering data using the on-screen keyboard, refer to “Entering data in your Sony CLIÉ™ handheld: Practicing entering data using the on-screen keyboard” in the “Handbook.”

● **Software keyboard (page 46)**

The working of the software keyboard is the same as the on-screen keyboard, however the applications can be used without minimizing the current screen.

● **Graffiti®**

You can enter data using an exclusive input system called Graffiti®. Once you get used to writing with Graffiti®, you will find that it is much faster than using the on-screen keyboard.

➔ For details on using Graffiti®, refer to “Entering data in your Sony CLIÉ™ handheld: Using Graffiti® writing to enter data” in the “Handbook.”

● **HotSync® operation with a computer**

You can enter data using your computer keyboard with a HotSync® operation. Text data is transferred from your computer to your CLIÉ handheld by a HotSync® operation using the Palm™ Desktop for CLIÉ software.

➔ For details, refer to the Help menu in the Palm™ Desktop for CLIÉ software.

Taking images/ movies

Taking images

The simple way to take images

- 1 Set your CLIÉ handheld to the turned style and open the camera lens cover.

Tip

Set your CLIÉ handheld to the opened style when you take images of yourself.

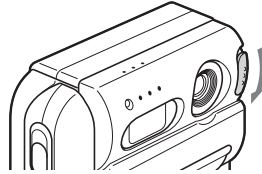

- 2 Press the CAPTURE button to start “CLIE Camera S.”
The application starts after a few seconds.

Tip

You can also select the CLIE Cam S  icon in “CLIE Launcher” (page 47) to start “CLIE Camera S.”

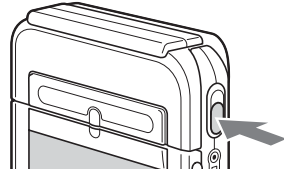

- 3 Capture the subject in the viewfinder and press and hold the CAPTURE button half way down.
Your CLIÉ handheld beeps and focuses on the subject.



- 4 Press the CAPTURE button fully down.
The shutter clicks and an image is taken.

Locating components on the "CLIE Camera S" screen

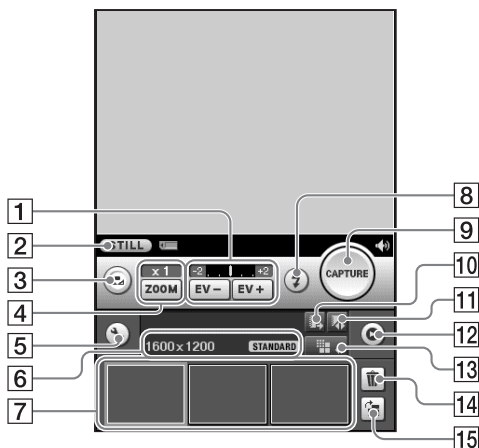

- 1 EV Adjustment (Page 59)**
- 2 "Movie Recorder" Start Button**
Switches the application to "Movie Recorder" for taking movies.
- 3 Custom Button (Page 56)**
- 4 Zoom Magnification (Page 59)**
- 5 Setup Button**
Displays the **Camera Setup** screen.
- 6 Image Size/Quality Display (Page 53)**
- 7 Image Thumbnail Display**
Displays the last three images you have taken.
- 8 Flash Mode Button (Page 58)**
- 9 CAPTURE Button**
Tap the button to take an image.
- 10 Album Start Button**
Starts "CLIE Album."
- 11 Album Select Button**
Tap the button to select the album where the taken images are located.
- 12 Viewer Start Button**
Starts "CLIE Viewer" to display the taken images.
- 13 Image Size/Quality Select Button (Page 53)**
- 14 Delete Button**
Deletes an image selected in the image thumbnail display.
- 15 Rotate Button**
Rotates an image selected in the image thumbnail display 90 degrees clockwise.

Using functions

Using the self-timer

- 1 Tap the Setup  button to display the **Camera Setup** screen.



- 2 Tap **Self Timer** and select  **On**. Tap the **OK** button.  (Self-timer) is displayed on the screen.

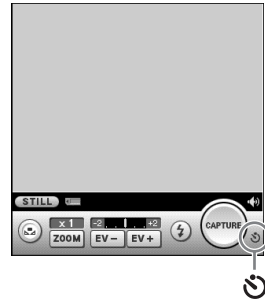
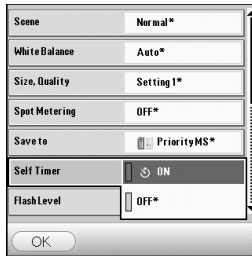

- 3 Capture the subject in the viewfinder and press the **CAPTURE** button fully down. Countdown starts and the image will be taken after approximately 10 seconds.

Tip

To cancel the self-timer during the operation

Tap the  button on the right of the countdown bar.

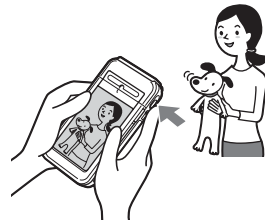

Note

If you stand in front of the camera and press the **CAPTURE** button, the focus and exposure may not be configured properly.

Selecting the image size/quality

You can select the image size (number of pixels) and image quality (compression ratio), depending on the purpose. By tapping the  button, you can select a favorite setting from three kinds of preset entries.

Presetting image size/quality

- 1 Tap the Setup  button to display the **Camera Setup** screen.



- 2 Tap **Size, Quality** to display the **Size, Quality** screen.



- 3 Select the image size/quality from the list and tap the **OK** button.

Tip

The larger image size or lower compression ratio improves images but then requires a larger amount of memory. This means the number of images you can save in the memory of your CLIÉ handheld or “Memory Stick” media will be reduced. Select the image size and image quality that suits your purpose.

- ➔ For details, refer to “CLIE Camera S” in the “CLIE Application Manual” installed on your computer.

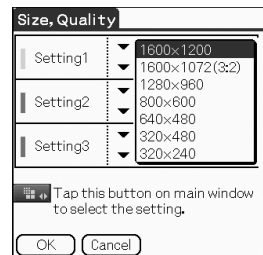

Selecting the location to where the captured images are to be saved

- 1 Tap the Setup  button to display the **Camera Setup** screen.



- 2 Tap **Save to** to select the location to where the captured images are to be saved.

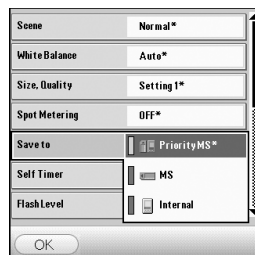

Priority MS	If a “Memory Stick” media is inserted into the slot, captured images will be saved on the “Memory Stick” media. If not, captured images will be saved in the memory of your CLIÉ handheld. Even if the free space of an inserted “Memory Stick” media is insufficient, captured images will not be saved in the memory of your CLIÉ handheld. (Default)
MS	Captured images will be saved on “Memory Stick” media.
Internal	Captured images will be saved in the memory of your CLIÉ handheld.

Selecting the scene mode

When taking images of scenes or people at night, you can use the scene mode to enhance the impact of the image.

- 1 Tap the Setup  button to display the **Camera Setup** screen.



- 2 Tap **Scene** to select the scene mode.



Normal Select this mode normally. (Default)

 **Twilight**

You can take images of a night scene without ruining the effect of the scene. Since the shutter speed becomes slower, make sure you keep the camera still. The flash is not available in this mode.



 **Twilight Portrait**

You can select this mode when taking images of people and a night scene at a time. You can take images of people with distinct outlines as well as a night scene without ruining the effect of the scene. Since the shutter speed becomes slower, make sure you keep the camera still. The flash works automatically.



Assigning a function to the custom button

You can assign your favorite function to the custom button.

- 1 Tap the Setup  button to display the **Camera Setup** screen.

Custom button
The icon varies depending on the assigned function.



- 2 Tap **Custom Button** and to select a function you want to assign.

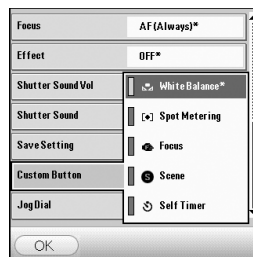

Selecting the shutter sound

You can select the volume and tone quality of the shutter sound.

- 1 Tap the Setup  button to display the **Camera Setup** screen.



- 2 Tap **Shutter Sound Vol** to set the volume of the shutter sound.
Tap **Shutter Sound** to select the tone quality of the shutter sound.

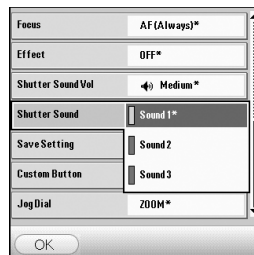
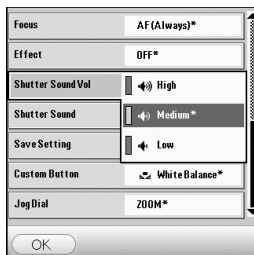

Selecting the flash mode

You can select the flash mode according to the situation.

- 1 Tap the flash mode  button and select a flash mode.

The Flash mode icon is displayed.

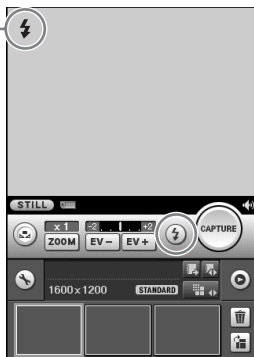

Auto	The flash works automatically in poor light conditions. (Default)
⚡ On (Flashes forcibly)	The flash works every time.
⚡ Off (No flash)	The flash is turned off.

Note

Do not use a flash towards the eyes from a short distance, as a visual disturbance may occur, especially when taking pictures of a baby. Be sure to maintain a distance of at least one meter from the baby when taking a picture with a flash.

Other functions

- For details, refer to “CLIE Camera S” in the “CLIE Application Manual” installed on your computer.

Main screen

Zoom	Tap the ZOOM button to switch between the two stages of adjustment.
EV Adjustment	Tap the EV - / EV + button to adjust the exposure.

Camera Setup screen

White Balance	<p>You can adjust the white balance.</p> <p>When the white balance is set to Auto, the white balance is adjusted automatically according to the condition. If you want to fix the setting or to take images under specific lighting conditions, you can adjust the white balance manually.</p> <p>(Default: Auto)</p>
Spot Metering	<p>You can adjust the exposure to the subject even when taking images against the sun or the contrast between the subject and background is high.</p> <p>(Default: OFF)</p>
Flash Level	<p>You can adjust the brightness of the flash.</p> <p>(Default: Normal)</p>
Red Eye Reduction	<p>Before taking images, the flash pre-strobes to reduce the red-eye phenomenon.</p> <p>(Default: OFF)</p>
Focus	<p>You can select a focusing method</p> <p>(Default: AF (Always))</p>
Effect	<p>You can add special effects to bring out the contrast in images.</p> <p>(Default: OFF)</p>
Save Settings	<p>You can choose either to maintain current settings or restore default settings at the start of the next function.</p> <p>(Default: Restoring default settings for all)</p>
Jog Dial	<p>You can assign your favorite function to the Jog Dial™ navigator.</p> <p>(Default: ZOOM)</p>

.....

Enjoying image files

Preparing



Taking images

CLIE Camera Spage 89

Importing image files from your computer

Image Converterpage 89



Viewing/Selecting



Viewing/Selecting image files by searching from the list

CLIE Viewerpage 90



Using features



Managing image files in albums

CLIE Albumpage 90

Importing image files from your CLIE handheld to your computer

PictureGear Studiopage 91



Displaying image files automatically

PhotoStand.....page 91



Editing image files

Photo Editor.....page 92



Attaching image files to an address

Addresspage 94



Sending image files by e-mail

CLIE Mail.....page 96



Transferring image files to your computer

Memory Stick Importpage 98

Recording movies

Recording movies

- 1 Set your CLIE handheld to the turned style and open the camera lens cover.

Tip

Set your CLIE handheld to the opened style when you record movies of yourself.

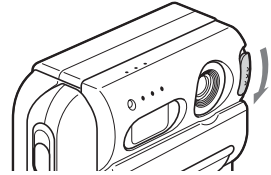

- 2 Insert the "Memory Stick" media to which you want to save movie files.

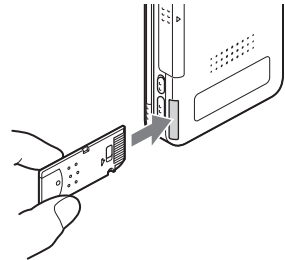

- 3 Select Movie Rec  icon in "CLIE Launcher" (page 47) to start.

The application starts after a few seconds.



- 4** Capture the subject in the viewfinder and press the CAPTURE button.
Movie recording starts.

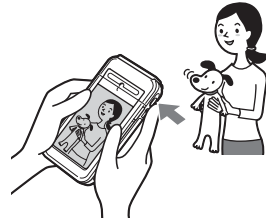

- 5** Press the CAPTURE button once again to stop movie recording.

.....

Enjoying movies

Preparing



Recording movies

Movie Recorder page 92

Importing movie files from your computer

Image Converter page 89

Giga Pocket Plugin page 90



Viewing/Selecting



Viewing/selecting a movie file after searching from the list

CLIE Viewer page 90



Playing movies

Movie Player page 92



Sending



Sending movie files by e-mail



CLIE Mail..... page 96

Viewing/Playing back files (CLIE Viewer)

You can use “CLIE Viewer” to view image files, movie files, handwritten memos and play back voice memos saved on your CLIE handheld.

➔ For details, refer to the “CLIE Application Manual” installed on your computer.

Opening/Playing back files

- 1 Tap the Home  icon to display the CLIE Launcher screen.
- 2 Select the CLIE Viewer  icon to start “CLIE Viewer.”

Tip

You can also start “CLIE Viewer” by selecting the  icon in the “CLIE Camera S” window.



- 3 Rotate the Jog Dial™ navigator to select the file you want to display and press the Jog Dial™ navigator. The selected file is displayed.

Tip

You can also display the file by tapping the file icon.
The files are listed in order of creation date and time.







.....

Selecting/Deleting files

You can select a file from the list screen in CLIE Viewer when attaching image files or movie files of your CLIE handheld to e-mails, when using the image files in “PhotoStand” (page 91), “CLIE Album” (page 90) and “Photo Editor” (page 92), or when deleting files.

1 Start “CLIE Viewer” and tap the command button to select the function.

-  : Select the file to be attached to an e-mail
This icon is displayed if “CLIE Mail” is installed.
-  : Select the image file to be used in “PhotoStand”
-  : Select the file to be deleted
-  : Select other applications such as “Photo Editor” or “CLIE Album” by using the pull-down menu



2 Tap to select the check box of the file.

Tip

Tap **Select All** to select all the files.

3 Tap **OK**.

The function selected in step 1 is executed.

Using your CLIÉ™ handheld with your computer

Follow the procedure below prior to using your CLIÉ handheld with your computer.

- 1** Install the software on your computer
- 2** Connect the cradle to your computer
- 3** Enter a user name for your CLIÉ handheld

Step 1: Install the software on your computer

Do not connect the supplied cradle to your computer before installing the software. The software may not be installed properly.

The “Palm™ Desktop for CLIÉ” software stored on the supplied CD-ROM must be installed on your computer. The software is used for data transfer between your CLIÉ handheld and computer, and handling data such as Address Book on your computer.

- For details on the system required on a computer, refer to “System required on a computer” on page 111.

Notes

- Do not simply copy the “Palm™ Desktop for CLIÉ” folder from the supplied CD-ROM to your computer. To install the software properly, follow the installation procedure described in this manual.
- If you use Windows 2000 Professional or Windows XP operating system, log on with a User Name in the Administrators group before installing the software.

Continued on next page

- If you own another CLIÉ handheld and the old version of “Palm™ Desktop for CLIÉ” has been already installed on your computer, follow the procedure below to upgrade to the new version.
 - * If you are using PEG-N710C or PEG-S300, refer to the official Sony CLIÉ website (refer to the back cover of this manual for the URL).
 - ➔ For details, refer to “Using data with another Sony CLIÉ handheld” in the “Handbook.”

1 Quit all applications running in Windows®.

2 Insert the supplied CD-ROM into the CD-ROM drive of your computer.

The “Installation Launcher” window is displayed.

3 Click the **Install** button for the **Palm Desktop for CLIÉ** software.

The setup program starts and the Welcome screen is displayed.

4 Click **Next**.

The Palm™ Desktop for CLIÉ software installation begins.

Follow the on-screen instructions.

5 Select the software you will use to synchronize your CLIÉ handheld with your computer.

If you select “Synchronize with Palm Desktop for CLIÉ,” Intellisync Lite software will not be installed. If you select “Synchronize with Microsoft Outlook or Lotus Organizer,” the Palm™ Desktop for CLIÉ software and Intellisync Lite software will be installed.

6 Click **Next**.

The Setup Type window is displayed.

7 Select the setup type (**Complete** or **Custom**) and the destination folder (if **Custom** is chose).

8 Fill in the user name in the **Create User Account** screen.

9 Click **Next**.

The **Connections** dialog box is displayed.

10 Select **USB** or **Serial Port**.

11 Click **Next**.

The **Ready to Install the Program** dialog box is displayed, Click **Install** to start installation.

12 Follow the on-screen instructions to finish installing the Palm™ Desktop for CLIÉ software.

13 Click **Finish**.

Installation of the Palm™ Desktop for CLIÉ software on your computer is completed.

Step 2: Connect the cradle to your computer

When you have completed the Palm™ Desktop for CLIE software installation, connect the cradle to a USB port of your computer so you can use your CLIE handheld with your computer.

Connect the cradle to your computer

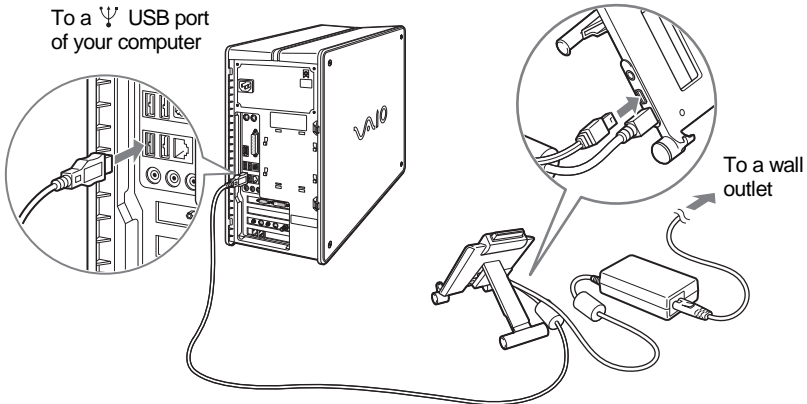

Note

Be sure to connect the cradle directly to a USB port of your computer. If the cradle is connected to a computer via another device, such as a USB hub, a HotSync® operation may not be performed properly.

Step 3: Enter a user name for your CLIÉ handheld

- 1 Place your CLIÉ handheld in the cradle.

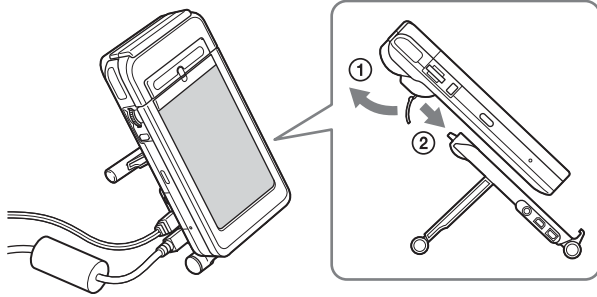

- 2 Press the HotSync  button on the cradle.

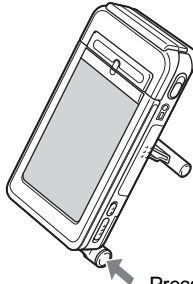

Press the HotSync  button

The USB Driver installation starts automatically.

- 3** When the New User dialog box is displayed on your computer window, enter your user name.
You can enter any user name you prefer.

Note

If you have already used another CLIÉ handheld

Enter a user name that is different from the one you use for another CLIÉ handheld. If you set an identical user name to multiple CLIÉ handhelds, improper operation may occur.

Tip

When you import data from another CLIÉ handheld

Refer to “Using data with another Sony CLIÉ handheld” in the “Handbook.”

- 4** Click **OK** on the computer window.
A beep sounds and the HotSync[®] operation starts.
Your user name selected in step 3 is transferred to the CLIÉ handheld.
When the setup is complete, “HotSync operation complete.” will be displayed on your CLIÉ handheld.

Setup is completed!

Synchronizing data between your CLIÉ handheld and computer (HotSync®)

What is a HotSync® operation?

A HotSync® operation is a one-step operation that allows you to synchronize data between your CLIÉ handheld and your computer, back up the data of your CLIÉ handheld on your computer, and install add-on applications.

- ➔ For details, refer to “Exchanging and updating data using a HotSync® operation (Other HotSync® operations)” in the “Handbook.”

Performing a HotSync® operation

The following procedure explains how to synchronize data between your CLIÉ handheld and computer, using “Date Book” as an example.

- 1** Turn on the computer.
- 2** Refer to the procedure on page 76 and enter data in “Date Book.”
- 3** Place your CLIÉ handheld in the cradle.

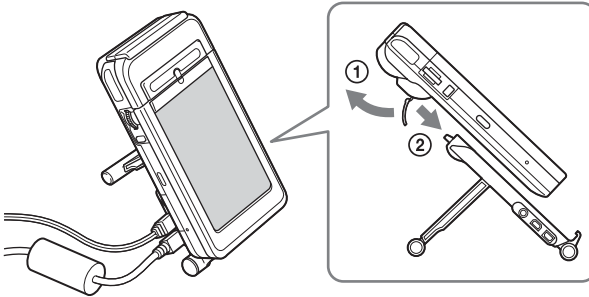

- 4** Press the HotSync  button on the cradle.
The HotSync operation between your CLIÉ handheld and computer starts.

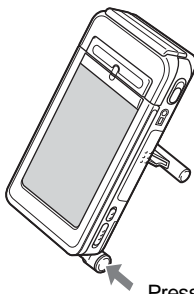

Press the HotSync  button

When the HotSync[®] operation is complete, the following screen is displayed.

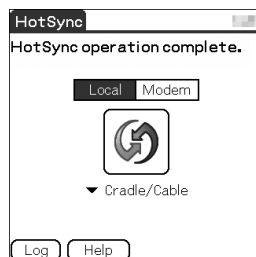

- 5** Double-click the “Palm™ Desktop for CLIÉ” icon on the Windows desktop.
You can also click **Start**, select **Programs (All Programs** in Windows XP), **Sony handheld**, and click **Palm Desktop for CLIÉ** to start the application.
The Palm™ Desktop for CLIÉ software starts.

- 6** Click the Date Book  icon.

The Date Book window is displayed.
If you select the same date you entered the schedule for in step 2, you will see the entered schedule.

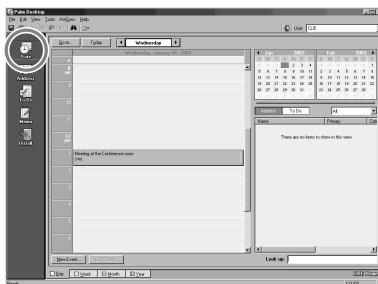

Enjoying your CLIE™ handheld

Using your CLIE handheld to view image files and movie files taken with “Memory Stick”-compliant devices

Tip

You can view the following file formats on your CLIE handheld:

Image files: JPEG (DCF) format, PictureGear Pocket format

Movie files: Movie Player format (movies taken with your CLIE handheld or converted using the Image Converter software), MPEG Movie format (MPEG1 format movies taken with a Sony Digital Still Camera or Handycam)

For formats of pictures that can be taken with your “Memory Stick” compliant devices, refer to their respective operating instructions.

- 1 Insert the “Memory Stick” media to which you have saved image files and movie files in your CLIE handheld.

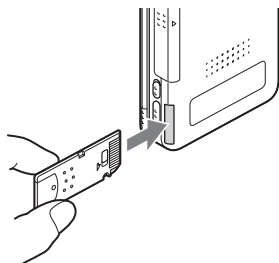

- 2 Start “CLIE Viewer” to view image files or movie files.
 - ➔ For details, refer to “Viewing/Playing back files (CLIE Viewer)” on page 63.

Using voice recorder

Recording a voice memo

- 1 Select the Voice Rec  icon in the CLIE Launcher screen (page 47) and start it.



- 2 Press the VOICE REC button.
The recording starts. Speak into the built-in microphone.

Tip

As soon as the VOICE REC button is pressed, “Voice Recorder” automatically starts and then recording starts.



- 3 Press the button once again to stop recording.

Playing back a voice memo

A voice memo can be played using “Voice Recorder” or “CLIE Viewer.”

- For details about “Voice Recorder,” refer to “Voice Recorder” in the “CLIE Application Manual” installed on your computer.
- For details about “CLIE Viewer,” refer to “Viewing/Playing back files (CLIE Viewer)” on page 63.

Listening to music

Note

You need to perform the following procedure to listen to music on your CLIÉ handheld.

- 1 Transfer music files you want to play, from your computer to your CLIÉ handheld.

➔ For details, refer to “Music” in the “CLIÉ Application Manual” installed on your computer.

- 2 Connect the supplied remote control and headphones to the CLIÉ handheld.

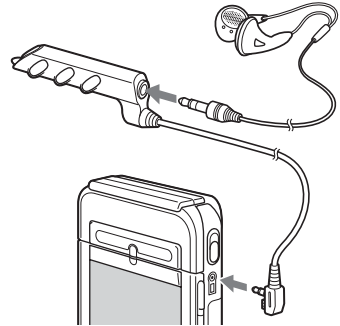

- 3 Select the AudioPlayer  icon in the CLIÉ Launcher screen (page 47) and start it.

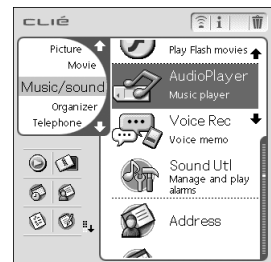

- 4 Tap the playback  button to play music.

Tap the stop  button to stop the music.



Playback button

Stop button

Tip

You can also use the remote control.

Managing schedules (Date Book)

..... Entering a schedule

1 Press the  button to start "Date Book."

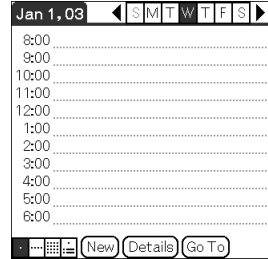

2 Tap **New** and set the start time and end time of the schedule.

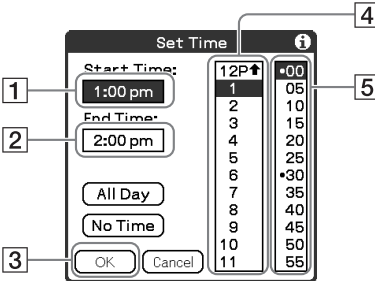

- 1 Tap to set the start time.
- 2 Tap to set the end time.
- 3 Tap to determine the settings.
- 4 Tap to select "hour."
- 5 Tap to select "minute."

3 Enter a schedule.



.....

Deleting a schedule

- 1 Tap a schedule you want to delete and tap the Menu  icon from the Date Book list screen.
- 2 Tap **Delete Event...** from the **Record** menu.
The confirmation message is displayed.

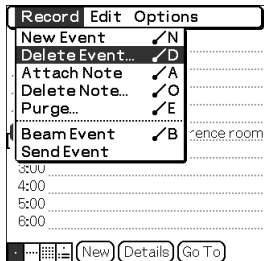

- 3 Tap **OK**.

Managing addresses and telephone numbers (Address)

Entering a new address

- 1 Press the  button to start "Address".
- 2 Tap **New** and enter details.

Tip

You can scroll the screen by tapping the ▲/▼ arrow in the bottom right-hand corner.

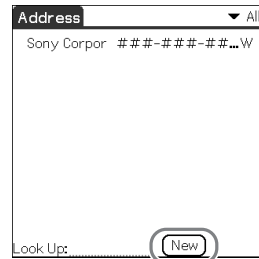

Deleting an address entry

- 1 Tap an address you want to delete and tap the Menu  icon.
- 2 Tap **Delete Address...** from the **Record** menu.
The confirmation message is displayed.

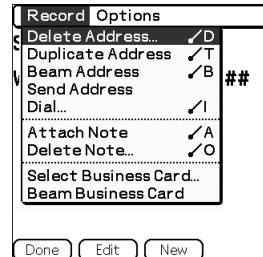

- 3 Tap **OK**.

Exchanging Date Book and Address data between your CLIÉ handheld and computer

HotSync[®] operation (page 71) enables you to exchange Date Book data and the Address data between your CLIÉ handheld and computer.

Depending on the applications that you use on your computer, there are two ways to exchange data.

Exchanging data between your CLIÉ handheld and Palm™ Desktop for CLIÉ software on your computer

You can synchronize data between “Date Book” or “Address” managed by the Palm™ Desktop for CLIÉ software on your computer and your CLIÉ handheld.

- For details on how to exchange data with the Palm™ Desktop for CLIÉ software, refer to “Synchronizing data between your CLIÉ handheld and computer (HotSync[®])” (page 71).

Exchanging data between your CLIÉ handheld and Microsoft® Outlook (Intellisync® Lite) in your computer

“Intellisync Lite” must be installed on your computer to connect with “Microsoft® Outlook” and “Lotus Organizer.”

- For details on how to install, refer to “Installing add-on applications on your CLIÉ handheld” (page 88).

Tip

The Intellisync Lite software can be installed with the option “Using your CLIÉ handheld” of the installer menu screen.

- For details on how to start and setup, refer to the help of “Intellisync Lite.” To view help, click **Programs** (In case of Windows XP, click **All Programs**) from the **Start** menu, then click **Intellisync Lite** and **Intellisync Help**.

Viewing computer documents on your CLIÉ handheld (Picsel Viewer for CLIE)

Note

Perform the following procedure before using “Picsel Viewer for CLIE” application.

- 1** Install “Picsel Viewer for CLIE” in your CLIÉ handheld.
- 2** Transfer documents from your computer to a “Memory Stick” media.
Use “Memory Stick Import” to transport documents to the “Memory Stick” media inserted into the slot of your CLIÉ handheld.



- 3** Start “Picsel Viewer for CLIE” on your CLIÉ handheld and view the documents transferred from your computer.
➔ For details, refer to “Picsel Viewer for CLIE” in the “CLIÉ Application Manual” installed on your computer.

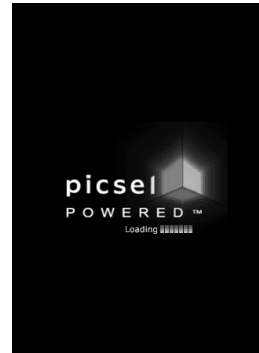

Connecting to the Internet

Note

For an internet connection, you must have a network card that is compliant with your CLIÉ handheld and you must be registered with an Internet Service Provider.

..... Installing applications in your CLIÉ handheld

Install applications on your CLIÉ handheld for your purposes.

Browsing websites on your CLIÉ handheld: NetFront v3.0 for CLIE (page 96)

Exchanging e-mail: CLIE Mail (page 96)

➤ For details about the necessary set-up of each application, refer to the “CLIÉ Application Manual” installed on your computer.

..... Setting up a network card

Set up a network card, such as “Wireless LAN card PEGA-WL100”.

Tip

For details on how to set up a network card, refer to the manual of each network card.

..... Connecting to the Internet

- 1** Insert the network card into your CLIÉ handheld.
- 2** Select the desired application in “CLIÉ Launcher” (page 47) and start it.
- 3** Start browsing websites, sending or receiving e-mail. Internet connection starts automatically.

Tip

When you want to attach image files or movie files from your CLIÉ handheld to an e-mail, you can select those files from the list displayed in “CLIÉ Viewer”.

➤ For details, refer to “Selecting/Deleting files” (page 64).

Using the Bluetooth™ function

Note

The communication speed and communication range vary depending on factors such as obstacles between devices, radio wave conditions, or specifications of a target device.

The Bluetooth™ function enables wireless communication within a range of approximately 10 meters. You can use the function to exchange data between your CLIÉ handheld and other Bluetooth compliant devices.

To use the Bluetooth™ function, select **Bluetooth** in the **Preferences** screen and set to **Enabled** for the **Bluetooth** item.

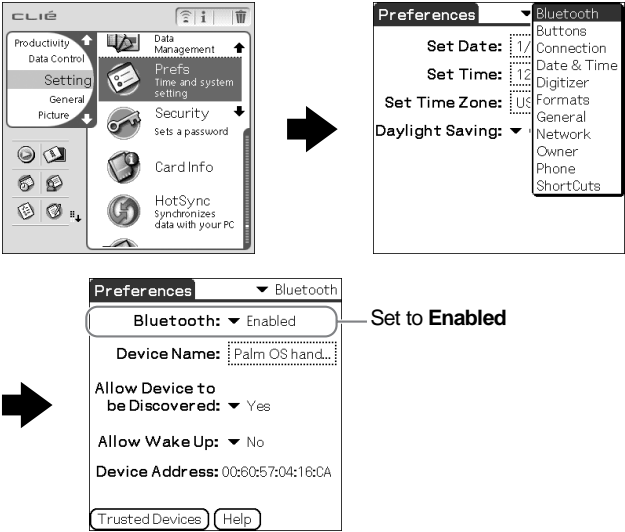

Bluetooth LED

The LED lights up during data exchange using the Bluetooth™ function. It blinks when the function is on standby.

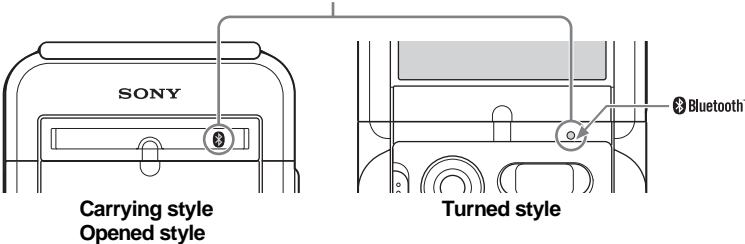

➤ For details, refer to “Customizing your Sony CLIÉ handheld (Preferences): Setting the Bluetooth™ function” in the “Handbook.”

.....

Sending data such as image files or Date Book data to another CLIE™ handheld with the built-in Bluetooth function or Bluetooth Module (optional)

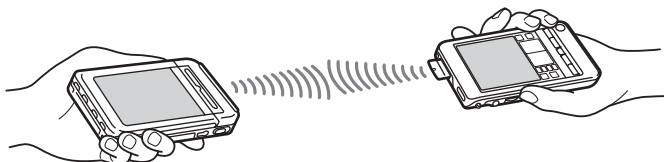

1 Select a file.

■ Sending an image file, movie file, voice memo, or handwritten memo

Start CLIE Viewer (page 63), tap the Menu  icon, select **Send...** from the **Data** menu, and tap a file you want to send.

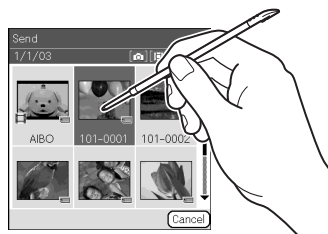

Tip

Sending image files

You can select a method of sending data in the dialog box. (The dialog box below may not be displayed depending on your operating environment)

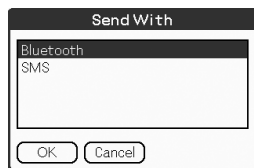

■ Sending Date Book data or Address data

Tap schedule data or address data you want to send, tap the Menu  icon, and then select **Send Event** (for “Date Book”) or **Send Address** (for “Address”) from the menu.

2 Send a file.

After the **Bluetooth Discovery** dialog box is displayed, the list of Bluetooth compatible CLIÉ handhelds within a range of the communication area is displayed on the **Discovery Results** dialog box. Tap to select a CLIÉ handheld to which you want to send data.

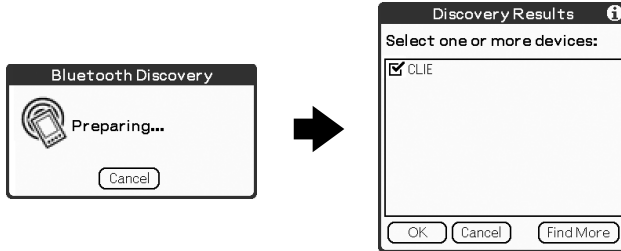

The **Bluetooth Progress** dialog box will be displayed on both CLIÉ handhelds. Follow the on-screen instructions.

Tip

If you have renamed a target Bluetooth™ compatible device registered on CLIÉ handheld, the device may be listed in the previous name when you detect target Bluetooth™ compatible devices.

In this case, follow the procedure below.

- 1 Tap the Menu  icon from the **Bluetooth Preferences** screen (page 82).
- 2 Tap **Disable device name cache** from the **Options** menu.
- 3 Detect target Bluetooth™ compatible devices.

Note

To view or edit received data/files, applications supporting each data/file must be installed on the CLIÉ handheld.

Performing a wireless HotSync® operation with a computer

If you are using a Bluetooth compatible computer, you can perform a wireless HotSync® operation between your CLIÉ handheld and computer.

- For details, refer to “Exchanging and updating data using a HotSync® operation (Other HotSync® operations) : Performing a HotSync® operation using the Bluetooth™ function” in the “Handbook.”

For information about Bluetooth™ compatible computers, refer to the Sony CLIÉ handheld Support website (<http://www.ita.sel.sony.com/support/cli/>).

Using the Bluetooth function between your CLIÉ handheld and other Bluetooth compliant devices

You can make full use of the Bluetooth function between your CLIÉ handheld and other Bluetooth compliant devices.



- For details, refer to the official Sony CLIÉ website.

Customers in the U.S.A, Canada and Mexico: <http://www.ita.sel.sony.com/support/cli/sccess/>

Customers in Asia-Pacific Countries: <http://vaio-online.sony.com/cli/>

Using applications

This chapter describes how to use add-on applications and the “CLIÉ Application Manual.” For details about add-on applications, refer to the manuals for each add-on application.

About add-on applications

Applications are divided into three types as follows:

- **Applications already installed on your CLIÉ handheld**
- **Applications you need to install on your CLIÉ handheld**

For details about using the Installation CD-ROM, follow the procedure on page 88.

- **Applications you need to install on your computer**

Using CLIÉ Application Manual

For details about using the add-on applications, refer to the “CLIÉ Application Manual” installed on your computer.



Notes

- Prior to using applications, refer to “Installing the software on your computer” on page 65 to install the Palm™ Desktop for CLIÉ software. The “CLIÉ Application Manual” will be installed at the same time.
- The “CLIÉ Application Manual” requires “Microsoft Internet Explorer Version 5.0” or later to be displayed properly.

Opening CLIÉ Application Manual

- 1 Double-click the CLIÉ info icon on the Windows desktop. “CLIÉ info” window is displayed.
- 2 Select the manual by following the on-screen instructions.

Tips

- To close the “CLIÉ Application Manual,” click the  icon in the top right-hand corner in the CLIÉ Application Manual window.
- You can minimize the CLIÉ Application Manual window by clicking the  icon in the top right-hand corner in the window. The minimized window can be reopened by clicking the CLIÉ Application Manual button in the task bar.
- You can operate other software while the CLIÉ Application Manual window is displayed on the Windows desktop.

Installing add-on applications on your CLIÉ handheld

You can install applications with the supplied Installation CD-ROM by following the procedure below.

Prior to installing applications, install the Palm™ Desktop for CLIÉ software on your computer with the supplied Installation CD-ROM and connect the cradle to your computer.

Note

The add-on applications are designed to operate on PEG-NZ90 only. Compatibility with other CLIÉ handheld or Palm OS PDAs is not guaranteed.

- 1** Quit all applications running on the Windows® operating system.
- 2** Insert the Installation CD-ROM into the CD-ROM drive of your computer.
The installation launcher window appears.
- 3** Click **CLIÉ Desktop**.
- 4** Click **Install** to the right of **CLIÉ Add-ons**.
- 5** Select the add-on applications to install.
- 6** Click **Next**.
- 7** Select the User.
- 8** Click **OK**.
- 9** Click **Done**.
- 10** To install the application on your CLIÉ handheld, press the HotSync button on the cradle.

Introducing add-on applications



Taking images

- Application to be used
CLIE Camera S **CLIE handheld**
- Keyword
JPEG (DCF) format
- Summary
For taking images using the built-in camera of the CLIE handheld.
- Preparation for use: **Installed**



➔ For details, refer to the “CLIE Application Manual” installed on your computer.

Importing image/movie files from your computer

- Application to be used
Image Converter **PC**
- Keyword
JPEG (DCF) format, Movie Player format
- Summary
For converting the formats of pictures on your computer so that they can be viewed on your CLIE handheld.
- Preparation for use: **Must be installed**
Requires a “Memory Stick” media
- Installation CD-ROM Menu
“CLIE Image”

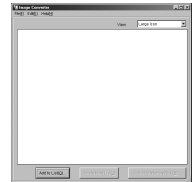

➔ For details, refer to the “CLIE Application Manual” installed on your computer.

Importing movie files from your computer

Application to be used
Giga Pocket Plugin PC

Keyword
Movie Player format

Summary
For converting the formats of movie files on your computer so that they can be viewed on your CLIÉ handheld.

Preparation for use: Must be installed
Requires a “Memory Stick” media

Installation CD-ROM Menu
“CLIÉ Image”

➔ For details, refer to Help files of the “Giga Pocket Plugin” installed on your computer.



Viewing/Playing back a file after searching from the list

Application to be used
CLIE Viewer CLIÉ handheld

Summary
For managing and displaying image files, movie files, handwriting memos and Voice memo files.

Preparation for use: Installed

➔ For details, refer to the “CLIÉ Application Manual” installed on your computer.



Managing image files in albums

Application to be used
CLIE Album CLIÉ handheld

Summary
For managing image files saved on your CLIÉ handheld or “Memory Stick” media, in an album format.
You can print out contents of the “CLIE Album” screen or view them on a television.

Preparation for use: Installed

➔ For details, refer to the “CLIÉ Application Manual” installed on your computer.



Managing image files taken with your CLIÉ handheld on your computer



■ **Application to be used**
PictureGear Studio PC

■ **Summary**

For importing image files from your CLIÉ handheld to your computer and managing the image files.

- Creates albums or binders for image files
- Imports image files to the computer and manages the image files
- Prints out labels
- Exchanges data created using the CLIE Album application between your CLIÉ handheld and computer.

■ **Preparation for use:** Must be installed

Requires a “Memory Stick” media

■ **Installation CD-ROM Menu**

“CLIÉ Image”

➔ For details, refer to the “CLIÉ Application Manual” installed on your computer.

Displaying image files automatically

■ **Application to be used**
PhotoStand CLIÉ handheld

■ **Keyword**

JPEG (DCF) format

■ **Summary**

For displaying automatically image files one after the other.

■ **Preparation for use:** Installed

➔ For details, refer to the “CLIÉ Application Manual” installed on your computer.

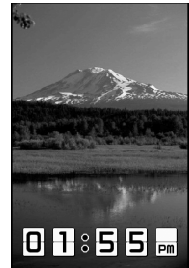



Editing images

Application to be used
Photo Editor CLIÉ handheld

Keyword
JPEG (DCF) format

Summary

For drawing pictures on an image file saved on your CLIÉ handheld. You can also draw pictures on a new blank canvas.

Preparation for use: **Installed**

For details, refer to the “CLIÉ Application Manual” installed on your computer.



Recording movies

Application to be used
Movie Recorder CLIÉ handheld

Keyword
Movie Player format (movie formats shot with your CLIÉ handheld or converted using the Image Converter software)

Summary

For recording movies using the built-in camera of the CLIÉ handheld.

Preparation for use: **Installed** **Requires a “Memory Stick” media**

For details, refer to the “CLIÉ Application Manual” installed on your computer.

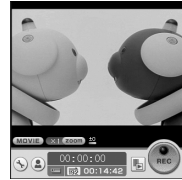

www.aibo.com



Playing back movies

Application to be used
Movie Player CLIÉ handheld

Keyword
Movie Player format (movie formats shot with your CLIÉ handheld or converted using the Image Converter software), MPEG Movie format (MPEG1 format movie files shot with a Sony Digital Still Camera or Handycam),
Play List, Repeat function, Index function

Summary

For playing back movies recorded with the built-in camera of the CLIÉ handheld or playing back movies on your CLIÉ handheld using “Image Converter” software on your computer.

Preparation for use: **Installed** **Requires a “Memory Stick” media**

For details, refer to the “CLIÉ Application Manual” installed on your computer.



www.aibo.com

Playing back Macromedia® Flash™

- Application to be used
Macromedia Flash Player 5

CLIÉ handheld

- Keyword

swf format

- Summary

For playing back the Macromedia Flash contents.

Some Flash contents for computers may not be played back normally on your CLIÉ handheld.

- Preparation for use: **Installed** **Requires a “Memory Stick” media**

➔ For details, refer to the “CLIÉ Application Manual” installed on your computer.



Listening to music with your CLIÉ handheld

- Application to be used

Audio Player **CLIÉ handheld**

- Keyword

MP3, ATRAC3

- Summary

For playing back music files saved on a “Memory Stick” media.

- Preparation for use: **Installed**

Needs to be connected to your computer

Requires a “Memory Stick” media

➔ For details, refer to the “CLIÉ Application Manual” installed on your computer.



Transferring music files to your CLIÉ handheld



■ **Application to be used**
SonicStage 1.5 PC

■ **Keyword**
ATRAC3

■ **Summary**

For managing and creating music files to be played back with your CLIÉ handheld in your computer.

The application is also used for transferring music files to a “Memory Stick” media.

■ **Preparation for use:** Must be installed

■ **Installation CD-ROM Menu**
“CLIÉ Audio”

➔ For details, refer to the “CLIÉ Application Manual” and Help files of “SonicStage” on your computer.

Recording voice memo

■ **Application to be used**
Voice Recorder CLIÉ handheld

■ **Summary**

For recording and playing back a voice memo using the built-in microphone of your CLIÉ handheld.

■ **Preparation for use:** Installed



➔ For details, refer to the “CLIÉ Application Manual” installed on your computer.

Managing addresses and telephone numbers

■ **Application to be used**
Address CLIÉ handheld

■ **Summary**

For entering and editing Address information such as names, addresses or telephone numbers.

■ **Preparation for use:** Installed

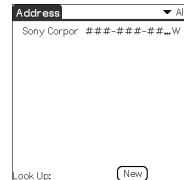

➔ For details, refer to the “CLIÉ Application Manual” installed on your computer.



Managing schedules and events

- Application to be used
Date Book CLIÉ handheld

- Summary**

For managing schedules and events such as meetings or business trips.

- Preparation for use:** Installed

➔ For details, refer to the “CLIÉ Application Manual” installed on your computer.

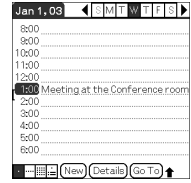

Managing tasks and things to do

- Application to be used
To Do List CLIÉ handheld

- Summary**

For displaying tasks that you want to be reminded of later. You can assign priority to any task.

- Preparation for use:** Installed

➔ For details, refer to the “CLIÉ Application Manual” installed on your computer.

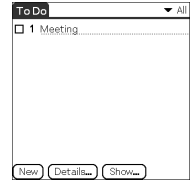

Taking memos

- Application to be used
Memo Pad CLIÉ handheld

- Summary**

For taking memos or displaying documents created on your computer.

- Preparation for use:** Installed

➔ For details, refer to the “CLIÉ Application Manual” installed on your computer.

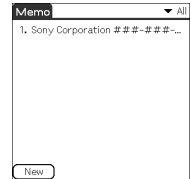

Taking handwritten memos using the stylus

- Application to be used
CLIE Memo CLIÉ handheld

- Summary**

For taking handwritten memos using the stylus.

- Preparation for use:** Installed

➔ For details, refer to the “CLIÉ Application Manual” installed on your computer.

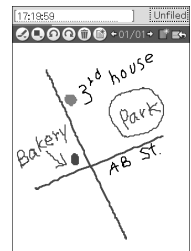



Using the calculator

Application to be used

Calculator CLIE handheld

Summary

For calculating with your CLIE handheld. You can save and recall calculations with the calculator's memory.

Preparation for use: Installed

➔ For details, refer to the "CLIE Application Manual" installed on your computer.

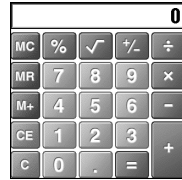

Sending and receiving e-mail messages

Application to be used

CLIE Mail CLIE handheld

Summary

For sending and receiving e-mail messages on your CLIE handheld.

Preparation for use: Must be installed

Installation CD-ROM Menu

"CLIE Desktop" – "CLIE Add-ons"

➔ For details, refer to the "CLIE Application Manual" installed on your computer.

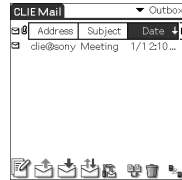

Browsing websites

Application to be used

NetFront v3.0 for CLIE CLIE handheld

Keyword

Websites, Internet, WWW browser

Summary

For browsing websites with your CLIE handheld.

Preparation for use: Must be installed

Installation CD-ROM Menu

"CLIE Desktop" – "CLIE Add-ons"

➔ For details, refer to the "CLIE Application Manual" installed on your computer.



Using as a remote control

Application to be used
CLIE Remote Commander

CLIE handheld



Keyword

Beaming

Summary

For using your CLIE handheld as a remote control.

Preparation for use: **Installed**

➔ For details, refer to the “CLIE Application Manual” installed on your computer.

Displaying the worldwide local time

Application to be used
World Alarm Clock CLIE handheld

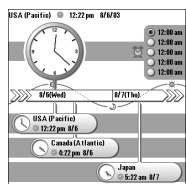

Summary

For displaying the worldwide local time. You can also use the application as an alarm clock.

Preparation for use: **Must be installed**

Installation CD-ROM Menu

“CLIE Desktop” – “CLIE Add-ons”

➔ For details, refer to the “CLIE Application Manual” installed on your computer.

Exchanging data between your CLIE handheld and “Memory Stick” media

Application to be used
CLIE Files CLIE handheld



Summary

For exchanging data (copy, move, delete) between your CLIE handheld and “Memory Stick” media inserted in the CLIE handheld or for editing data on your “Memory Stick” media.

Preparation for use: **Installed** **Requires a “Memory Stick” media**

➔ For details, refer to the “CLIE Application Manual” installed on your computer.

Making a backup on a “Memory Stick” media

Application to be used
Memory Stick Backup CLIÉ handheld

Summary

For making a backup of the application or data in a “Memory Stick” media.

Preparation for use: Installed Requires a “Memory Stick” media

➔ For details, refer to the “CLIÉ Application Manual” installed on your computer.

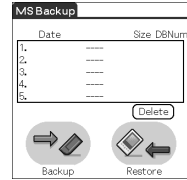

Using a “Memory Stick” media in your CLIÉ handheld on a computer

Application to be used
Memory Stick Import CLIÉ handheld
Memory Stick Export PC

Summary

For installing application or copying data from your computer to a “Memory Stick” media in your CLIÉ handheld without using a HotSync[®] operation.

Preparation for use: Requires a “Memory Stick” media

Memory Stick Import: Installed

Memory Stick Export: Must be installed

Installation CD-ROM Menu

“CLIÉ Utilities”

➔ For details, refer to the “CLIÉ Application Manual” installed on your computer.

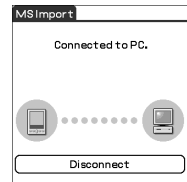

Customizing the sound settings

Application to be used
Sound Utility CLIÉ handheld

Summary

For managing the audio data converted with Sound Converter 2. The audio data files are transferred from your computer to your CLIÉ handheld via a HotSync[®] operation.

Preparation for use: Installed
Needs to be connected to your computer

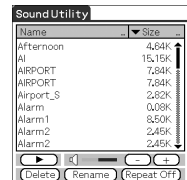

➔ For details, refer to the “CLIÉ Application Manual” installed on your computer.

Sending audio data to your CLIÉ handheld



- **Application to be used**
Sound Converter 2 PC

- **Keyword**
WAVE (PCM) format, MIDI (Standard MIDI File Format 0/1) format

- **Summary**
For converting the audio data of WAVE (PCM) format or MIDI format in your computer to audio data of the CLIÉ handheld format.

- **Preparation for use:** Must be installed

- **Installation CD-ROM Menu**
"CLIÉ Utilities"

➔ For details, refer to the "CLIÉ Application Manual" installed on your computer.

Viewing computer documents on your CLIÉ handheld

- **Application to be used**
Picseel Viewer for CLIE CLIÉ handheld

- **Keyword**
doc format, xls format, ppt format, txt format, JPEG format, GIF format, PNG format, BMP format, PDF format, HTML format, MHTML format

- **Summary**
For viewing computer documents such as Microsoft Word/Excel data on your CLIÉ handheld.

- **Preparation for use:** Must be installed
Requires a "Memory Stick" media

- **Installation CD-ROM Menu**
"CLIÉ Desktop" – "CLIÉ Add-ons"

➔ For details, refer to the "CLIÉ Application Manual" installed on your computer.



Exchanging data with Microsoft® Outlook

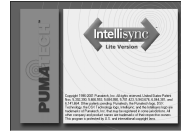

Application to be used
Intellisync Lite PC

Summary

For exchanging the data between Microsoft Outlook/Lotus Organizer and Date Book, Address, To Do, etc., of the CLIÉ handheld.

Preparation for use: **Must be installed**

Needs to be connected to your computer

Installation CD-ROM Menu

Select **Palm Desktop for CLIÉ** from **CLIÉ Desktop**, and follow the on-screen instructions.

➔ For details, refer to the “CLIÉ Application Manual” and Help files of “Intellisync Lite” installed on your computer.



Sending/Receiving messages and data via a connected GSM wireless device

Application to be used
SMS CLIÉ handheld

Summary

For sending/receiving messages and data from your CLIÉ handheld via a connected GSM wireless device, such as a mobile phone.

Preparation for use: Installed

➔ For details, refer to the “CLIÉ Application Manual” installed on your computer.



Troubleshooting

This section describes how to solve common problems you may encounter when using your CLIÉ handheld.

Preventing problems

..... Making a backup is recommended

We recommend that you make a backup of your data in case of any unexpected trouble. Backing up your data will ensure that it will be saved on the CLIÉ handheld even when you have to perform a hard reset.

Making a backup using the Memory Stick Backup application

You can make a backup on the “Memory Stick” media using the supplied Memory Stick Backup application. This is the most convenient way to make a backup.

▶ **“Memory Stick” media (optional) is required.**

For details, refer to “Backing up your Sony CLIÉ handheld data” in the “Handbook.”

Making a backup using the HotSync® operation

The data of your CLIÉ handheld is backed up on your computer every time you perform a HotSync® operation. You can lose the data in your CLIÉ handheld when you perform a hard reset. But, if you make a backup with the HotSync® operation, you can restore any data previously synchronized with your computer during the next HotSync® operation.

However, you cannot make a backup for the following applications or data using the HotSync® operation.

- Applications or data installed from “Memory Stick” media or beamed.
- Some applications and driver files added later, or some data in applications.

Continued on next page

For details on applications that cannot be backed up, refer to manuals for each application.

If you want to make a complete backup, use the Memory Stick Backup application. For details on HotSync, refer to “Exchanging and updating data using a HotSync® operation” in the “Handbook.”

Solving problems

Should you encounter problems, please follow the procedure below.

Sony recommends that you make a note of displayed messages or alerts to find the key to solve the problem.

Step 1 Refer to “Troubleshooting Q&A” or manuals for each application.

- Read “Troubleshooting Q&A” carefully.
- Double-click the CLIÉ Info icon, select **Manuals** and read the details about the applications.

Step 2 Refer to the Sony CLIÉ handheld Support website.

On the Sony CLIÉ handheld Support website (<http://www.ita.sel.sony.com/support/clie/>), you can see information for the answers to frequently asked questions (FAQ), download provisions of latest programs, information on how to connect peripheral devices etc.

Double-click the CLIÉ Info icon and select **CLIÉ Customer Support** on your computer.

Note

Thousands of third-party add-on applications are available for the Palm OS® platform. Sony does not support third-party applications. If you have a problem with a third-party application, contact the developer or publisher of that software.

Getting Help

Intellisync Lite:

Support information:

<http://www.pumatech.com/sonyclie/>

For CLIÉ handheld and applications other than the above mentioned:

Sony offers several support options for your CLIÉ handheld. If you have questions or problems, please refer to one of the following for a solution:

- **Read This First (this guide), Handbook (supplied), and Troubleshooting Q&A (supplied)** describes how to use your CLIÉ handheld.
- **Sony CLIÉ handheld support website**
<http://www.sony.com/peg/support/>
Provides the latest information on your CLIÉ handheld. On this website, you will find:
 - Frequently Asked Questions (FAQs)
 - Online Operating Instructions
 - Installation information
 - Software updates
 - Online knowledge base
- **The Sony e-mail support service** answers your questions by e-mail.
Send your question, and a customer service representative will send you a reply. You can use the e-mail form at
<http://www.sony.com/peg/support/>
- **The Sony fax-back service** provides you with answers to commonly asked questions. You can use this automated service to access a list of available topics and then select the topics that you want to receive. To contact the Sony fax-back service, call
1-877-760-SONY (7669).
- **The Sony Customer Information Service Center** offers information about your CLIÉ handheld and other Sony products that work with your computer. To contact the Sony Customer Information Service Center, call
1-877-760-SONY (7669).
- **Sony Product Registration website** (for customers in the U.S.A and Canada)
U.S.A: <http://www.sony.com/clie/register/>
Canada: <http://www.sony.com/clie/ca/register/>

Additional information

Notes on use

About handling

- Make sure you do not scratch or damage your CLIÉ handheld's screen or the Graffiti[®] writing area. Always use the supplied stylus or a plastic-tipped pointer to tap on the screen.
Do not use a real pen, pencil, or other sharp object on the screen.
- Do not expose your CLIÉ handheld to rain or moisture. Should water enter the circuitry through the buttons and switches, your CLIÉ handheld may be damaged.
- Your CLIÉ handheld screen is made of glass. Do not drop or expose your CLIÉ handheld to external shock. Do not carry your CLIÉ handheld in your back pocket. If you sit down with your CLIÉ handheld in the back pocket, the CLIÉ handheld may break.
- Avoid using or storing your CLIÉ handheld in locations subject to:
 - extremely high temperature, such as inside a car left exposed to the sun, or near a heater.
 - direct sunlight
 - high humidity
 - excessive dust
- The rubber feet of the cradle may lose their adhesion if they become dirty. If this occurs, wipe the rubber feet with a soft damp cloth to restore their adhesion.

About cleaning

- Clean your CLIÉ handheld with a soft, dry cloth.
- Remove the dirt and dust from the camera lens by wiping with a soft damp cotton swab.

If condensation occurs

Turn off your CLIÉ handheld for approximately one hour to clear condensation before use. If you leave condensation within the camera lens, you may not be able to take clear images.

.....

Battery considerations

Charging

- It takes approximately 4 hours to charge your CLIÉ handheld when the battery is empty.
- If you charge your CLIÉ handheld every day, it takes only a few minutes to charge the battery.
- You can operate your CLIÉ handheld while it is being charged.

Battery life

Battery life varies depending on the conditions and environment where you use your CLIÉ handheld, or applications used.

➔ For details, refer to “Specifications” on page 107.

Conserving the battery

- Turn off the backlight under good lighting conditions.
 - ➔ For details, refer to “POWER Switch” on page 31.
- Change the automatic power-off time setting so that your CLIÉ handheld will automatically turn off after a short period of inactivity.
 - ➔ For details, refer to “Customizing your Sony CLIÉ handheld (Preferences): Setting the automatic power-off time” in the “Handbook.”

Using peripheral devices

If the caution message that warns of low battery-remaining is displayed while you use peripheral devices with your CLIÉ handheld, stop using them immediately and charge your CLIÉ handheld. If you continue operating, data in your CLIÉ handheld’s memory may be lost.

When battery charge gets low

- When battery charge gets low, a caution message appears on the screen, and operations for “Memory Stick” media or backlight adjustment become unavailable.

If this occurs, perform a HotSync[®] operation to make a backup all the data of your CLIÉ handheld to your computer. Then charge your CLIÉ handheld using the cradle to prevent accidental data loss.

- If your CLIÉ handheld does not turn on when you slide the POWER switch, charge your CLIÉ handheld immediately.
- The remaining battery indicator does not always reflect the actual battery power remaining. To prevent the battery running out accidentally, charge it frequently even when it is not fully discharged.
- When the remaining battery indicator reads zero, immediately charge the battery with the USB cradle or replace with a charged battery.

Do not let the remaining battery indicator read 0

If your battery drains and you leave your CLIÉ handheld in an uncharged state for an extended period of time, all of the stored data will be erased. Sony recommends that you charge your CLIÉ handheld frequently.

Others

Your CLIÉ handheld may get warm if turned on for a long period. This is not malfunction.

Specifications

..... CLIE handheld

OS

Palm OS[®] 5 (ver.5.0)

CPU

PXA250 200 MHz

Memory

16 MB (RAM)

User memory range:
approx. 11 MB

External input/output

Interface connector
IrDA (1.2)
IR port for AV control
Bluetooth
“Memory Stick” slot
Wireless communication slot
(CompactFlash[®] type II)

Display

TFT color display with backlight,
320 × 480 dots, 65,536 colors

Other functions

FM synthesizer
16 chords
IMA ADPCM sound (monaural)
Monaural Speaker
Monaural Microphone

Dimensions (excluding projections)

Approx. 3 × 5 ⁵/₈ × ⁷/₈ inches
(75.0 × 141.0 × 22.2 mm) (w/h/d)

Weight

Approx. 11 oz (293 g) (including the
supplied stylus and battery)

Operating temperature

41 °F to 95 °F (5 °C to 35 °C)

Audio frequency response

20 Hz to 20,000 Hz

Audio recording format

ATRAC3
MP3 (~320 kbps)

Sampling frequency

44.1 kHz

Output

Headphone: Stereo mini-jack

Voice encoding/decoding format

IMA ADPCM (1ch, 4bit)
SP mode (22 kHz),
LP mode (8 kHz)

Maximum recording time

ATRAC3 format
(when using a 128MB “MagicGate
Memory Stick” media, sold
separately)
Approx. 120 minutes
(bit rate: 132 kbps)
Approx. 160 minutes
(bit rate: 105 kbps)
Approx. 240 minutes
(bit rate: 66 kbps)

MP3 format
(when using a 128MB “Memory Stick” media, sold separately)

Approx. 65 minutes

(bit rate: 256 kbps)

Approx. 170 minutes

(bit rate: 96 kbps)

Approx. 130 minutes

(bit rate: 128 kbps)

Maximum audio recording time

(when using a 128MB “Memory Stick” media, sold separately)

SP mode: Approx. 190 minutes

LP mode: Approx. 520 minutes

Power requirements

AC power adapter (supplied):

DC 5.2 V (dedicated connector)

(The supplied AC cord is for AC 120 V)

Battery:

Smart Lithium Battery Pack

(1,200 mAh)

Battery life

Operating PIMs:

10 days

(when PIMs, such as Date Book, are operated for 30 minutes per day with the backlight off)

6 days

(when PIMs, such as Date Book, are operated for 30 minutes per day with the backlight on)

Taking image files

(in continuous mode):

Approx. 1 hour

(when taking image files with the minimum backlight, no flash, VGA size, and Normal mode.)

Playing audio files
(in continuous mode):

Approx. 4 hours

(when playing audio files with the HOLD switch on)

Approx. 2.5 hours

(when playing audio files with the HOLD switch off and medium backlight)

Recording movie files

(in continuous mode):

Approx. 1 hour

(when recording movie files with the HOLD switch off and minimum backlight)

Viewing movie files

(in continuous mode):

Approx. 3 hours

(when viewing movie files with the backlight off)

Approx. 2 hours

(when viewing movie files with the backlight on)

Recording voice memos

(in continuous mode):

Approx. 6 hours

(when recording movie files with the HOLD switch on)

Approx. 2.5 hours

(when recording movie files with the HOLD switch off and maximum backlight)

Performing data communication

(in continuous mode):

Approx. 2.5 hours

(when performing data communication with PEGA-WL100)

* The battery life span varies depending on the temperature and conditions of use.

.....

Camera

Effective pixels

Approx. 2,000,000 pixels

Image pickup device

1/2.7 inch interlace scan CCD image sensor (2,110,000 pixels in total)

Lens

F2.8/focal length 5 mm
(35 mm film equivalent f=approx.
33 mm)

Focus range

AF=0.1 m to ∞

Flash range

0.5 m to 1.5 m

Camera finder

On the CLIÉ handheld display
Image file: 320 × 240 dots
Movie file: 320 × 224 dots

Others

White Balance:
Auto, Daylight, Cloudy,
Incandescent, Fluorescent
Picture effect:
Off, B&W, Sepia
Exposure value:
±2EV, 1/3EV step
Flash mode:
Auto, ON, OFF,
Red-eye reduction ON, OFF
Self-timer function:
10 seconds (for image file only)

Picture size (when recording)

Image file: 1600 × 1200,
1600 × 1072 (3:2),
1280 × 960, 800 × 600,
640 × 480, 320 × 480
(vertical frame),
320 × 240 dots

Movie file: 160 × 112 dots

Formats (when recording)

Image file: JPEG(DCF format)
Movie file: Movie Player format

Picture size (when viewing)

On the CLIÉ handheld display
Image file: 320 × 480, 320 × 240,
160 × 120 dots
Movie file: 426 × 320, 320 × 240
160 × 112 dots

Formats (when viewing)

Image file: JPEG (DCF format)
Movie file: Movie Player format,
MPEG Movie format

Maximum movie recording time

(when using 128MB “Memory Stick”
media, sold separately)
Note that the maximum movie
recording time in continuous
operation is approx. 60 minutes.
V:192/A: 32kbps :
Approx. 70 minutes
V:96/A: 32kbps :
Approx. 120 minutes

Maximum image file recording capacity

(when using a 128MB “Memory Stick” media in the standard mode)
1600 × 1200 dots: Approx. 300 files
1600 × 1072 dots (3:2): Approx. 340 files
1280 × 960 dots: Approx. 400 files
800 × 600 dots: Approx. 1,000 files
640 × 480 dots: Approx. 1,600 files
320 × 480 dots: Approx. 2,800 files
320 × 240 dots: Approx. 4,000 files

Operation confirmed network card

Wireless LAN card SONY
PEGA-WL100

Compatible printer

Tip

For the latest information, refer to the Sony CLIÉ handheld Support website (<http://www.ita.sel.sony.com/support/clié/>) and select your model.

Bluetooth function

Communication method

Bluetooth standard Ver. 1.1

Output

Bluetooth standard Power Class 2

Communication range ¹⁾

Line of sight approx. 10 m

Supported Bluetooth profiles ²⁾

Serial Port Profile
Dial-up Networking Profile
LAN Access Profile
Object Push Profile
Basic Imaging Profile

Frequency band

2.4 GHz band
(2.4000 GHz - 2.4835 GHz)

- ¹⁾ The actual range will vary depending on factors such as obstacles between devices, magnetic fields around a microwave oven, static electricity, interference, radio wave conditions, reception sensitivity or antenna’s performance, and operating system or software application, etc.
- ²⁾ Bluetooth standard profiles specify the usage purpose for Bluetooth devices communicating with each other.

.....

System required on a computer

You need one of the following systems installed on your computer to be able to use the Palm Desktop for CLIÉ software and software supplied on the CD-ROM:

- OS: Microsoft Windows 98 Second Edition, Windows Millennium Edition, Windows 2000 Professional, Windows XP Home Edition, Windows XP Professional
- CPU: Pentium II 400MHz or more (Pentium III 500MHz or more is recommended)
- RAM: 96MB or more (128MB or more is recommended, 256MB or more is recommended for Windows XP)
- Hard drive space: 200MB (350MB or more is recommended)
- Display: High Color or more, 800 × 600 dots or more is recommended
- CD-ROM drive
- USB port
- Pointing device such as a mouse or touchpad

Design and specifications are subject to change without notice.

INDEX

A

- AC adapter 21
- Add-On applications 88
- Address 78, 94
- Application manager icon 46
- Applications
 - Installing 88
 - Quitting 48
 - Using 47, 86
 - Using CLIE Application Manual 86
- Audio Player 93
- Audio Remote Control 18

B

- BACK Button 34
- Basic Operations 29
 - Using the Jog Dial™ navigator 30
 - Using the Stylus 29
- Battery
 - Charging 21
 - Considerations 105
 - Inserting 19
 - Removing 20
- Brightness adjustment icon 45

C

- Calculator 96
- Camera 33
- CAPTURE Button 32
- CLIE Album 90
- CLIE Camera S 89
- CLIE Files 97
- CLIE Launcher 47
- CLIE Mail 96
- CLIE Memo 95

- CLIE Remote Commander 97
- CLIE Viewer 63, 90
 - Opening/Playing Back Files 63
 - Selecting/Deleting Files 64
- Components 12
- Connect the cradle to your computer 68
- Connecting to the Internet 81
- Cradle 17, 21

D

- Date Book 76, 95
- Display panel 15
- Dragging 30

E

- Enjoying your CLIE handheld 73
- Entering data 49
- Exchanging Date Book and Address data 79

F

- Functions of parts 31

G

- Giga Pocket Plugin 90
- Graffiti® 46

H

- Hardware Keyboard 37
- HOLD Switch 34

I

Icons for switching the Graffiti/Software Keyboard	46
Image Converter	89
Image Files	
Enjoying	60
Initial screen	43
Initial settings	23
Intellisync Lite	100
IR port	35

J

Jog Dial™ navigator	30
-------------------------------	----

L

Listening to music	75
------------------------------	----

M

Macromedia Flash Player 5	93
Managing addresses and telephone numbers	78
Managing Schedules	76
Memo Pad	95
Memory Stick Backup	98
Memory Stick Export	98
Memory Stick Import	98
“Memory Stick” LED	36
“Memory Stick” media	73
“Memory Stick” Slot	36
Inserting a “Memory Stick” media	36
Removing a “Memory Stick” media	37
Movie files	73
Movie Player	92
Movie Recorder	92
Movies	
Enjoying	62
Recording movies	61

N

NetFront v3.0 for CLIE	96
----------------------------------	----

O

Operating style	15
Carrying style	15
Opened style	15
Turned style	16

P

Photo Editor	92
PhotoStand	91
Picxel Viewer for CLIE	99
PictureGear Studio	91
POWER LED	32
POWER Switch	31

R

REC LED	33
Restarting	40
Hard reset	41
Soft reset	40

S

Scroll Button	35
Set date	26
Set time	25
Setting up a network card	81
SMS	100
Software keyboard	46
SonicStage 1.5	94
Sound Converter 2	99
Sound Utility	98
Specifications	107
Status bar	44
Stylus	24, 29

Continued on next page

Index

T

Taking images	50
Assigning a function to the custom button	56
Effect	59
EV Adjustment	59
Flash Level	59
Flash mode	58
Focus	59
Image size/quality	53
Jog Dial	59
Locating components on the screen	51
Red Eye Reduction	59
Save Settings	59
Scene mode	55
Selecting the location to where the captured images are to be saved	54
Self-timer	52
Shutter sound	57
Spot Metering	59
White Balance	59
Zoom	59
Tapping	24, 29
Time zone	26
To Do List	95
Turning off	31
Turning on	31

U

USB port	68
Using the Bluetooth™ function	82
Using Voice Recorder	74

V

Viewing computer documents	80
Viewing image files	73
VOICE REC Button	33
Voice Recorder	94

W

WARNING	4, 6
Wireless Communication Slot	38
Inserting the Network Card	39
Removing the Network Card	39
World Alarm Clock	97



Contents of this manual are printed on chlorine-free paper using VOC (Volatile Organic Compound)-free vegetable-oil-based ink.

For the latest information on support
and accessories,
check our official Sony CLIE website
<http://www.sony.com/clie/>